

# Inoxsystem®

General catalogue #20

Deletes and replaces any previous version 

Stainless Steel - Think about your future

## Index Page

Introduction	2
Examples of application	4
Different types of channels	6
<b>Inoxsystem® product lines</b>	
Floor drains with square top plate	8
Gullies with grating	11
Slot channels	12
Gullies suitable for slot channels	14
Channels with grating	16
Gullies suitable for channels with grating	17
Standard lines with grating covers	18
Slot channels with standard slot	20
Slot channels with heelsafe slot	21
Recessed manhole covers and gratings for inspection	22
Recessed manhole covers with integrated odor trap	23
Corner guards and floor profiles	24
Flange for waterproof membrane application	26
Articles for vinyl flooring	29
Accessories	30
Inoxsystem® classic lines	32
<b>Inoxsystem® Total Hygienic lines</b>	
Inoxsystem® Total Hygienic floor drains with square top plate	44
Inoxsystem® Total Hygienic gullies with grating	46
Inoxsystem® Total Hygienic channels	48
Inoxsystem® Total Hygienic gratings	50
Inoxsystem® Total Hygienic floor drains with one floor drain-channel connection	52
Inoxsystem® Total Hygienic gullies with grating with one gully-channel connection	54
Inoxsystem® Total Hygienic lines	56



FLOOR DRAINS



GULLIES WITH GRATING



SLOT CHANNELS



CHANNELS WITH GRATING



SHOWER DRAINS ITALIA IDrain WITH TWO SIDE SLOTS



RECESSED MANHOLE COVERS



CORNER GUARDS AND FLOOR PROFILES



FLANGE FOR WATERPROOF MEMBRANE APPLICATION





**TOTAL HYGIENIC**  
Inoxsystem® Drainage Systems



INOXSYSTEM® TOTAL HYGIENIC

**Inoxsystem®**  
stainless steel drainage systems and accessories

[www.inoxsystem.it](http://www.inoxsystem.it) - [info@inoxsystem.it](mailto:info@inoxsystem.it)



Stainless steel is  
100% Recyclable



CERTIFIED COMPANY





# Best drainage system

## Inoxsystem® - Stainless steel drainage systems

Thanks to over 20 years' experience in the sector, ongoing research and cutting-edge techniques **Inoxsystem®** has become a leading company in the production of stainless steel drainage systems aiming at developing and producing high performance solutions for both newly built floors and renovation works.



Our strengths at **Inoxsystem®** are fast production, top quality material, customisation and an expert team always available to support our customers. In addition to a wide range of drainage systems such as slot channels, floor drains, channels with grating, gullies with grating and recessed manhole covers, entirely made of **AISI 304** or **AISI 316** stainless steel, **Inoxsystem®** presents the new **Inoxsystem® Total Hygienic** line.

Not only **Total Hygienic** systems are fully compliant with the highest hygienic requirements preventing harmful bacteria contamination but they are also designed to protect employees health and guarantee durability and high load capacity.

## Your projects... our ideas!

Detailed technical drawings

Made to measure items

Standard technical data sheets available

Project study

Study of flow rates and hygienic performance





# Handmade in Italy

Our standard models do not meet your requirements? No problem, all of our products can be customized according to your needs.

Indeed, any item is developed and manufactured in our factory in Italy by expert artisans who have been offering high quality drainage systems with a remarkable care of the details for over 20 years.

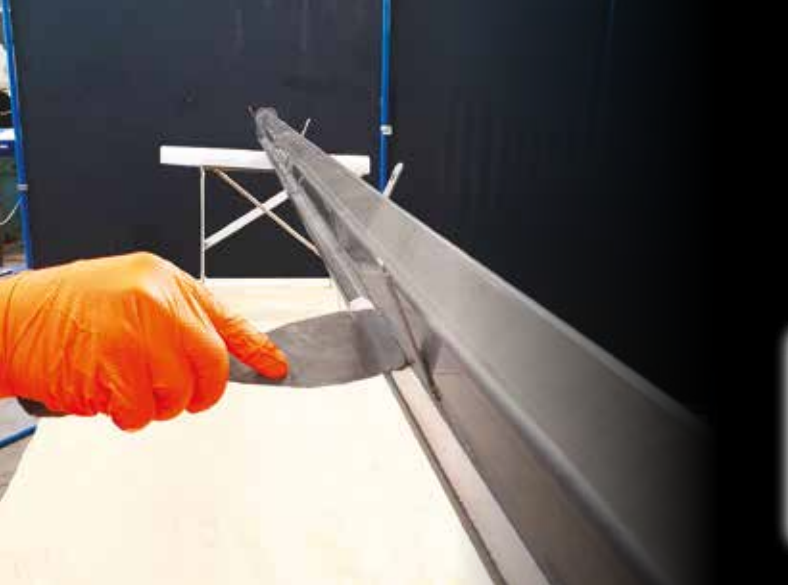

**Inoxsystem® Exclusive**  
top edge  
reinforced manually

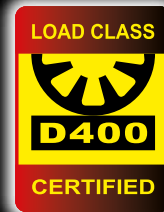

The channel top edge is filled manually with three-component epoxy-resin to provide greater rigidity to the channel and speed up installation. Thanks to this feature, **Inoxsystem®** channels are third party certified to D400 loading - resistance kn 400

## AISI 304 or AISI 316 stainless steel?

*Inoxsystem® recommends:*

### AISI 304



Food Industry



Pharmaceutical Industry



Industrial sector and Domestic use

### AISI 316



Environments with high salinity



Environments with chlorine content



Environments with acids at a high concentration

made of grade 304 stainless steel - grade 316 on request

### SHOWERS AND SPA



### SWIMMING POOLS



### SQUARES AND TERRACES



### CHANGING ROOMS





made of grade 304 stainless steel - grade 316 on request

### WINERIES



### PROFESSIONAL KITCHENS



### SLAUGHTER HOUSES AND BUTCHER SHOPS



### BREWERIES





made of grade 304 stainless steel - grade 316 on request

## STANDARD CHANNELS



## CHANNELS WITH FLANGE FOR WATERPROOF MEMBRANE APPLICATION



## CHANNELS WITH FOLDED EDGE AND FLANGE FOR WATERPROOF MEMBRANE APPLICATION

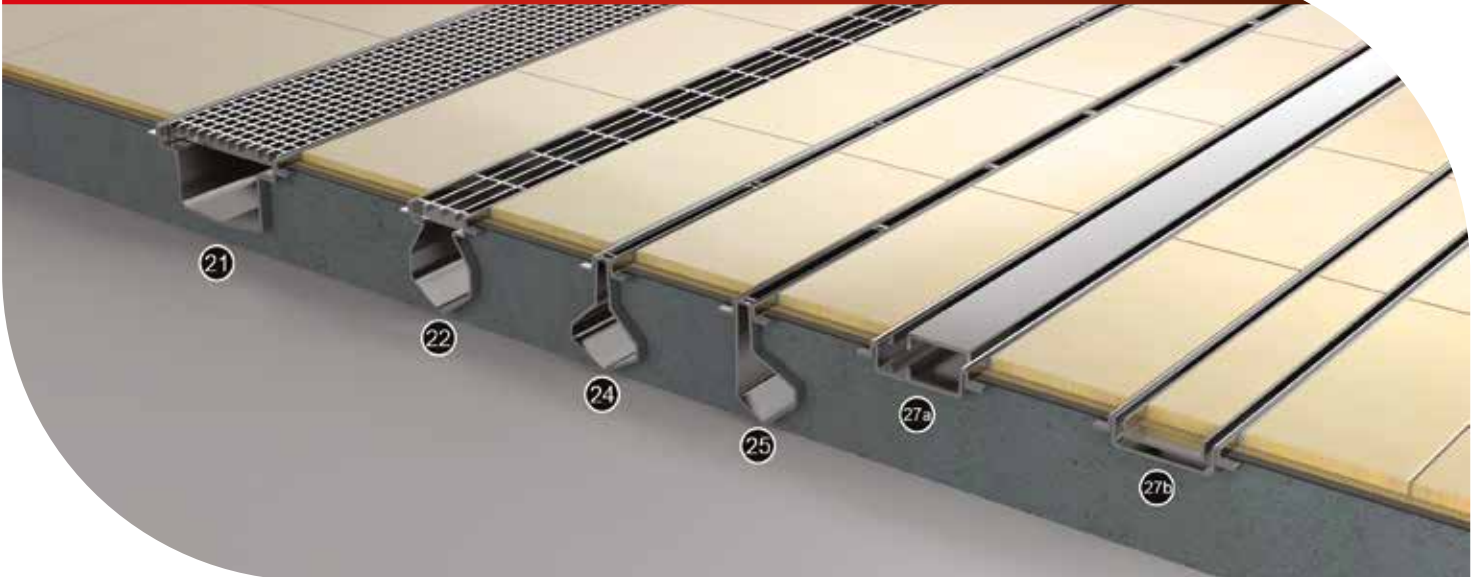



made of grade 304 stainless steel - grade 316 on request

## SLOT CHANNELS

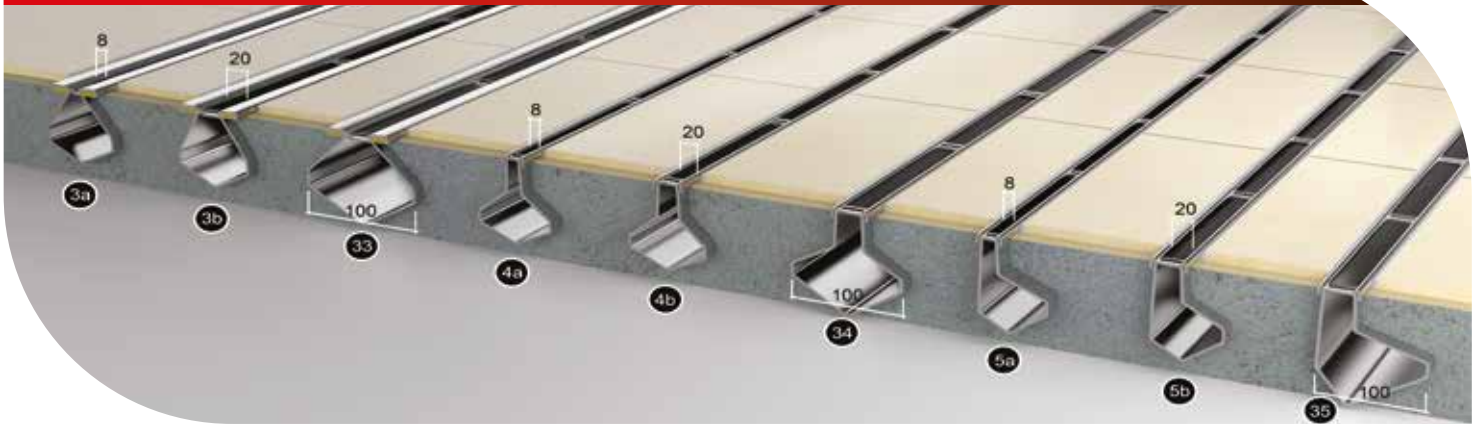

## GRATINGS FOR BOX CHANNELS



## GRATINGS FOR LINEAR SHOWER DRAINS Inoxsystem® ITALIA IDRAIN



## GRATINGS FOR Inoxsystem® TOTAL HYGIENIC CHANNELS

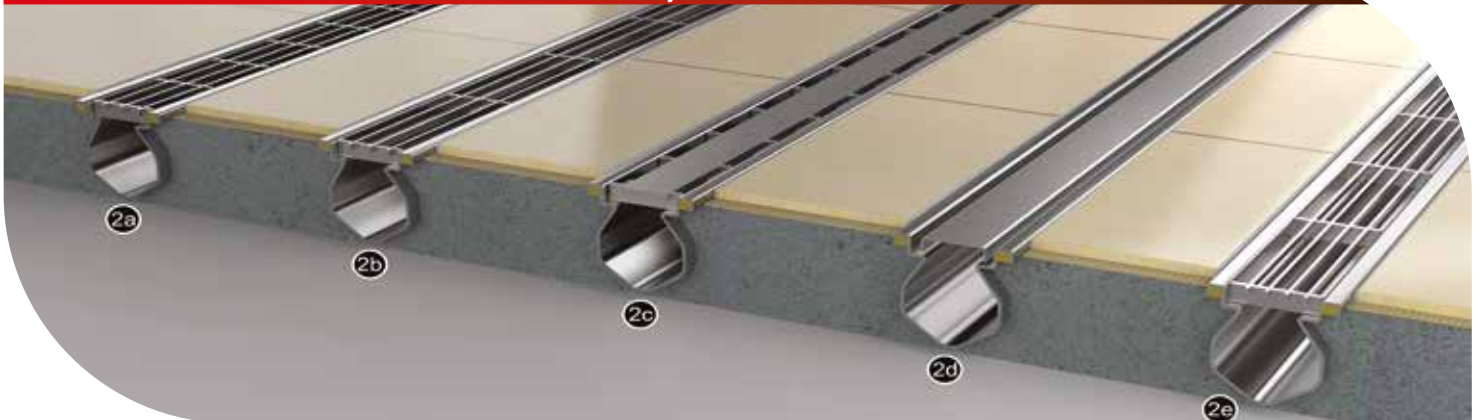

made of grade 304 stainless steel - grade 316 on request

### Standard and low profile floor drains with square top plate, vertical outlet and removable separated filter basket (after odor trap).

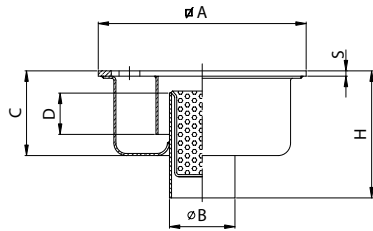

Dwg. No. 0113

Article	DIMENSIONS IN mm						FLOW RATE lt/min	LOAD CAPACITY IN Kg	
	Ø A	S	Ø B	C	D	H		CONCENTRATED LOAD	DISTRIBUTED LOAD
R-Low profile									
40 V 106	100	6	40	40	15	80	18	1000	10000
50 V 156	150	6	50	50	25	90	40	1000	10000
R 50 V 206	200	6	50	50	20	90	50	1000	10000
R 63 V 206	200	6	63	50	20	90	60	1000	10000
63 V 206	200	6	63	75	40	120	60	1000	10000
80 V 256	250	6	80	110	50	180	80	950	8500
R 104 V 256	250	6	104	60	20	120	135	950	8500
104 V 256	250	6	104	110	50	180	135	950	8500
104 V 258	250	8	104	110	50	180	135	1200	12000
R 104 V 306	300	6	104	60	20	120	135	950	8500
104 V 306	300	6	104	110	50	180	135	950	8500
R 110 V 308	300	8	110	60	20	120	135	1200	12000
110 V 308	300	8	110	110	50	180	135	1200	12000
110 V 358	350	8	110	130	50	200	135	900	8000
160 V 358	350	8	160	130	50	230	220	900	8000

- Different outlet diameters on request - heavy duty top covers made from 6/8 mm thick stainless steel plate  
N.B. water seal depth (dimension D) of 50 mm in compliance with standard UNI EN 1253-1



N.B. - Round top cover on request **Art. pt.**  
- See page 30 for other cover patterns **Art. ptf.**

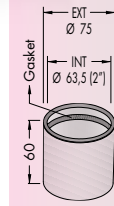
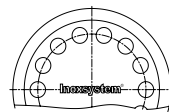

NOTE:  
PVC coupling to increase diameter size from 63 mm to 75 mm available **Art. 63S75**

### Standard and low profile floor drains with square top plate, vertical outlet and removable filter basket incorporated into the bell trap (before odor trap).

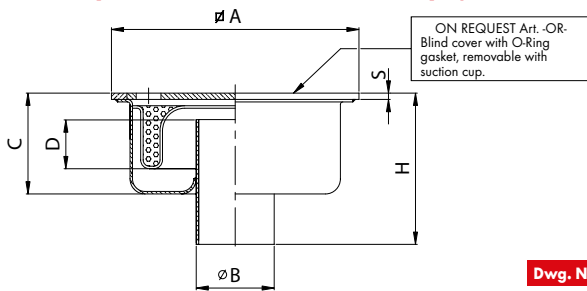

Dwg. No. 0114

Article	DIMENSIONS IN mm						FLOW RATE lt/min	LOAD CAPACITY IN Kg	
	Ø A	S	Ø B	C	D	H		CONCENTRATED LOAD	DISTRIBUTED LOAD
R-Low profile									
80 VCE 258	250	8	80	110	50	180	80	1000	10000
R 104 VCE 258	250	8	104	60	20	120	135	1000	10000
104 VCE 258	250	8	104	110	50	180	135	1000	10000
R 63 VCE 308	300	8	63	60	20	120	60	1000	10000
R 104 VCE 308	300	8	104	60	20	120	135	1000	10000
104 VCE 308	300	8	104	110	50	180	135	1000	10000
110 VCE 308	300	8	110	110	50	180	135	1000	10000
110 VCE 358	350	8	110	130	50	200	135	850	6500
160 VCE 358	350	8	160	130	50	230	220	850	6500

- Different outlet diameters on request - heavy duty top covers made from 6/8 mm thick stainless steel plate  
N.B. water seal depth (dimension D) of 50 mm in compliance with standard UNI EN 1253-1



N.B. - Round top cover on request **Art. pt.**  
- See page 30 for other cover patterns **Art. ptf.**

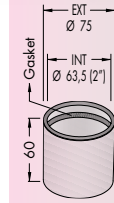
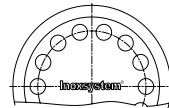

NOTE:  
PVC coupling to increase diameter size from 63 mm to 75 mm available **Art. 63S75**

### Standard and low profile floor drains with square top plate, vertical direct outlet and removable filter basket.

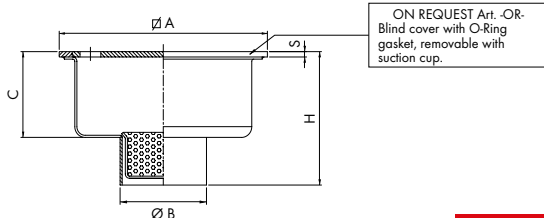

Dwg. No. 0118

Article	DIMENSIONS IN mm						FLOW RATE lt/min	LOAD CAPACITY IN Kg	
	Ø A	S	Ø B	C	D	H		CONCENTRATED LOAD	DISTRIBUTED LOAD
D 40 V 106	100	6	40	40	15	80	50	1000	10000
D 50 V 156	150	6	50	50	25	90	80	1000	10000
D 63 V 206	200	6	63	50	20	90	100	1000	10000
D 75 V 206	200	6	75	50	20	90	120	1000	10000
D 90 V 256	250	6	90	60	120	120	240	950	8500
D 100 V 258	250	8	100	60	120	120	300	1000	10000
D 110 V 308	300	8	110	60	120	120	340	1000	10000
D 160 V 358	350	8	160	130	200	200	700	850	6500

- Different outlet diameters on request - heavy duty top covers made from 6/8 mm thick stainless steel plate



N.B. - Round top cover on request **Art. pt.**  
- See page 30 for other cover patterns **Art. ptf.**

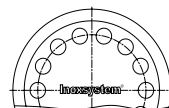

NOTE:  
PVC coupling to increase diameter size from 63 mm to 75 mm available **Art. 63S75**



made of grade 304 stainless steel - grade 316 on request

**Standard and low profile floor drains with square top plate, horizontal outlet and removable separated filter basket (after odor trap).**

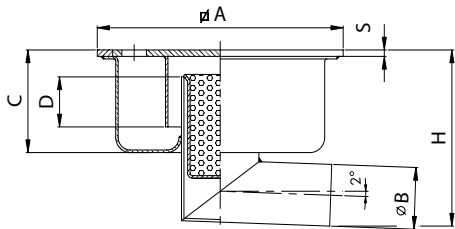

Dwg. No. 0010

N.B. - Round top cover on request **Art. pt.**  
- See page 30 for other cover patterns **Art. ptf.**

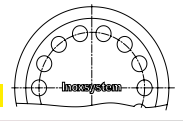

Article	DIMENSIONS IN mm						FLOW RATE lt/min	LOAD CAPACITY IN Kg		
	Ø A	S	Ø B	C	D	H		CONCENTRATED LOAD	DISTRIBUTED LOAD	
R-Low profile										
40 L 106	100	6	40	40	15	85	18	1000	10000	
50 L 156	150	6	50	50	20	105	40	1000	10000	
R 50 L 206	200	6	50	50	20	105	50	1000	10000	Low profile
R 63 L 206	200	6	63	50	20	115	60	1000	10000	Low profile
63 L 206	200	6	63	75	40	140	60	1000	10000	
80 L 256	250	6	80	110	50	200	80	950	8500	
R 104 L 256	250	6	104	60	20	175	135	950	8500	Low profile
104 L 256	250	6	104	110	50	230	135	950	8500	
104 L 256	250	8	104	110	50	230	135	1200	12000	
R 104 L 306	300	6	104	60	20	175	135	950	8500	Low profile
104 L 306	300	6	104	110	50	230	135	950	8500	
R 110 L 308	300	8	110	60	20	175	135	1200	12000	Low profile
110 L 308	300	8	110	110	50	230	135	1200	12000	Recommended
110 L 358	350	8	110	130	50	260	135	900	8000	
160 L 358	350	8	160	130	50	300	220	900	8000	Deep profile

- Different outlet diameters on request - heavy duty top covers made from 6/8 mm thick stainless steel plate  
N.B. water seal depth (dimension D) of 50 mm in compliance with standard UNI EN 1253-1



**NOTE:**  
PVC coupling to increase diameter size from 63 mm to 75 mm available  
**Art. 63S75**

**Standard and low profile floor drains with square top plate, horizontal outlet and removable filter basket incorporated into the bell trap (before odor trap).**

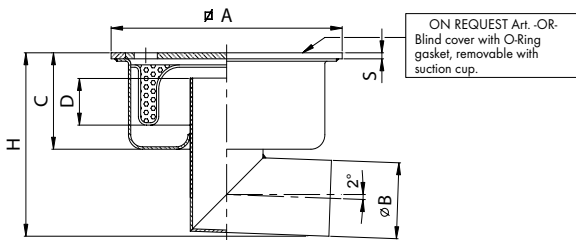

Dwg. No. 0009

N.B. - Round top cover on request **Art. pt.**  
- See page 30 for other cover patterns **Art. ptf.**



Article	DIMENSIONS IN mm						FLOW RATE lt/min	LOAD CAPACITY IN Kg		
	Ø A	S	Ø B	C	D	H		CONCENTRATED LOAD	DISTRIBUTED LOAD	
R-Low profile										
80 LCE 258	250	8	80	110	50	200	80	1000	10000	
R 104 LCE 258	250	8	104	60	20	175	135	1000	10000	Low profile
104 LCE 258	250	8	104	110	50	230	135	1000	10000	
R 63 LCE 308	300	8	63	60	20	125	60	1000	10000	Low profile
R 104 LCE 308	300	8	104	60	20	175	135	1000	10000	Low profile
104 LCE 308	300	8	104	110	50	230	135	1000	10000	
110 LCE 308	300	8	110	110	50	230	135	1000	10000	Recommended
110 LCE 358	350	8	110	130	50	260	135	850	6500	
160 LCE 358	350	8	160	130	50	300	220	850	6500	Deep profile

- Different outlet diameters on request - heavy duty top covers made from 6/8 mm thick stainless steel plate  
N.B. water seal depth (dimension D) of 50 mm in compliance with standard UNI EN 1253-1



**NOTE:**  
PVC coupling to increase diameter size from 63 mm to 75 mm available  
**Art. 63S75**

**Ultra-low profile floor drains with square top plate, horizontal outlet with odor trap and filter basket**

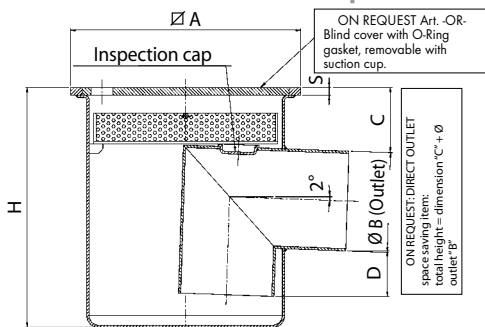

Dwg. No. 0011

N.B. - Round top cover on request **Art. pt.**  
- See page 30 for other cover patterns **Art. ptf.**



Article	DIMENSIONS IN mm						FLOW RATE lt/min	LOAD CAPACITY IN Kg		
	Ø A	S	Ø B	C	D	H		CONCENTRATED LOAD	DISTRIBUTED LOAD	
L 40 25 106	100	6	40	25	15	90	12	1000	10000	Ultra-low profile
L 50 25 156	150	6	50	25	15	105	40	1000	10000	Ultra-low profile
L 63 30 206	200	6	63	30	30	140	60	1000	10000	Ultra-low profile
L 104 40 258	250	8	104	40	50	220	80	1000	10000	Ultra-low profile
L 63 35 308	300	8	63	35	30	140	60	1000	10000	Ultra-low profile
L 110 40 308	300	8	110	40	50	220	135	1000	10000	Recommended
L 160 50 358	350	8	160	50	50	300	210	850	6500	Deep profile

- Different outlet diameters on request - heavy duty top covers made from 6/8 mm thick stainless steel plate



**NOTE:**  
PVC coupling to increase diameter size from 63 mm to 75 mm available  
**Art. 63S75**

Dimensions can be modified on request.

These technical drawings are property of INOXSYSTEM® and cannot be copied or reproduced without our prior written permission.

made of grade 304 stainless steel - grade 316 on request

### Floor drains with square top plate and double odor trap vertical outlet and removable filter basket.

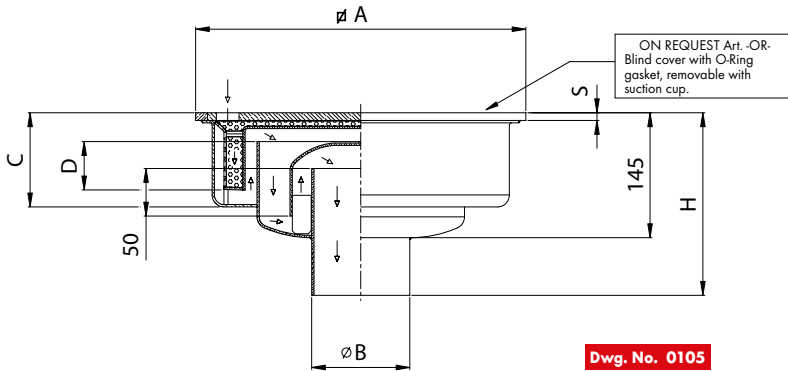

N.B. - Round top cover on request **Art. pt.**  
- See page 30 for other cover patterns **Art. ptf.**



Article	DIMENSIONS IN mm						FLOW RATE lt/min	LOAD CAPACITY IN Kg	
	∅ A	S	∅ B	C	D	H		CONCENTRATED LOAD	DISTRIBUTED LOAD
110 V 358 DS	350	8	110	130	50	220	120	850	6500

Horizontal outlet on request

- Different outlet diameters on request - heavy duty top covers made from 6/8 mm thick stainless steel plate

### Square top clean outs with blind cover and O-Ring gasket.

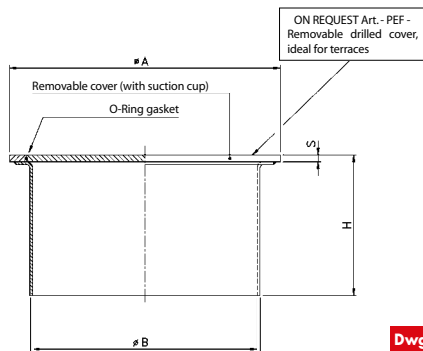

On request: we can provide suction cup **Art. Ventosa**

N.B. - Round top cover on request **Art. pt.**  
- See page 30 for other cover patterns **Art. ptf.**



Article	DIMENSIONS IN mm				LOAD CAPACITY IN Kg		
	∅ A	S	∅ B	H	CONCENTRATED LOAD	DISTRIBUTED LOAD	
75 OR 106	100	6	75	50	1000	10000	Drilled cover ideal for terraces available
110 OR 156	150	6	110	50	1000	10000	
160 OR 206	200	6	160	50	1000	10000	Drilled cover ideal for terraces available
215 OR 258	250	8	215	50	1000	10000	
215 OR 308	300	8	215	50	1000	10000	
315 OR 358	350	8	315	50	900	8000	

- Different outlet diameters on request - heavy duty top covers made from 6/8 mm thick stainless steel plate

### Ultra-low profile floor drains with direct outlet

for applications where installation height is limited.

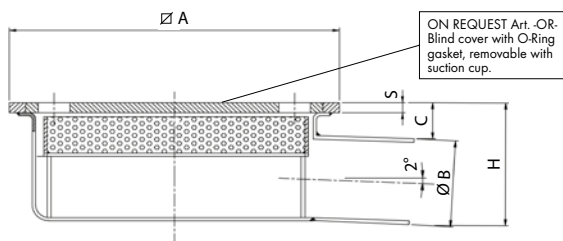

N.B. - Round top cover on request **Art. pt.**  
- See page 30 for other cover patterns **Art. ptf.**



N.B. - All dimensions can be customized on request

Article	DIMENSIONS IN mm					FLOW RATE lt/min	LOAD CAPACITY IN Kg	
	∅ A	S	∅ B	C	H		CONCENTRATED LOAD	DISTRIBUTED LOAD
D 40 L 106	100	6	40	20	60	50	1000	10000
D 50 L 156	150	6	50	20	70	80	1000	10000
D 63 L 206	200	6	63	22	85	100	1000	10000
D 75 L 206	200	6	75	25	100	120	1000	10000
D 75 L 258	250	8	75	25	100	160	1000	10000
D 110 L 308	300	8	110	30	140	340	1000	10000

- Different outlet diameters on request - heavy duty top covers made from 6/8 mm thick stainless steel plate

Dimensions can be modified on request.

These technical drawings are property of INOXSYSTEM® and cannot be copied or reproduced without our prior written permission.



made of grade 304 stainless steel - grade 316 on request

### Gullies with standard mesh grating, vertical outlet with odor trap and removable filter basket.

See page 18 for low profile version

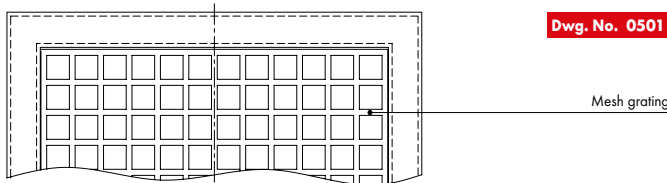
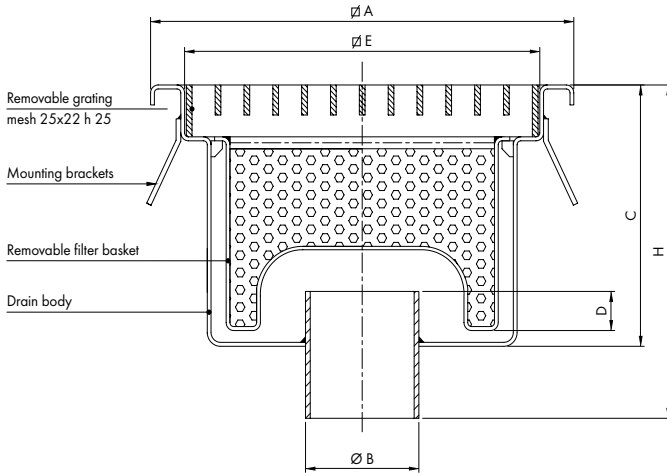

Article	DIMENSIONS IN mm						FLOW RATE lt/min	LOAD CAPACITY IN Kg	
	Ø A	Ø E	Ø B	C	D	H		CONCENTRATED LOAD	DISTRIBUTED LOAD
PGV 300 110	300	254	110	150	50	220	150	*	*
PGV 400 110	400	354	110	150	50	220	150	*	*
PGV 500 110	500	454	110	150	50	220	150	*	*

N.B. water seal depth (dimension D) of 50 mm in compliance with standard UNI EN 1253-1



See page 16 for different grating options

\* = These values depend on the type of grating.  
\*\* = Provided as standard

GRATING COVERS			
Standard grating	Heelsafe grating (on request)	Heavy duty ladder grating (on request)	Total Hygienic frameless grating (on request)
Mesh 25x22 **	50x11	25x8 - clear opening 20	Mesh 50x13

Other sizes

Article	DIMENSIONS IN mm						FLOW RATE lt/min	LOAD CAPACITY IN Kg	
	Ø A	Ø E	Ø B	C	D	H		CONCENTRATED LOAD	DISTRIBUTED LOAD
PGV 400 125	400	354	125	200	50	270	190	*	*
PGV 500 160	500	454	160	250	50	320	250	*	*

N.B. water seal depth (dimension D) of 50 mm in compliance with standard UNI EN 1253-1

### Gullies with standard mesh grating, horizontal outlet with odor trap and removable filter basket.

See page 19 for low profile version

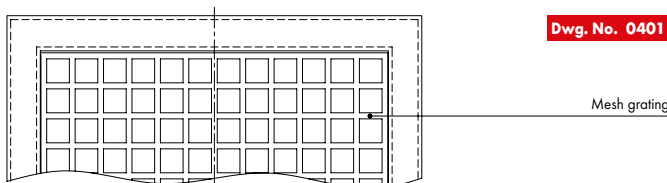
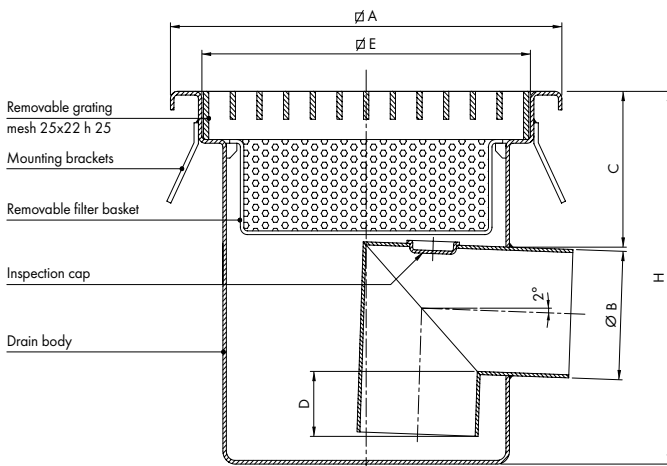

Article	DIMENSIONS IN mm						FLOW RATE lt/min	LOAD CAPACITY IN Kg	
	Ø A	Ø E	Ø B	C	D	H		CONCENTRATED LOAD	DISTRIBUTED LOAD
PGO 300 110	300	254	110	50	50	240	150	*	*
PGO 400 110	400	354	110	50	50	240	150	*	*
PGO 500 110	500	454	110	50	50	240	150	*	*

N.B. water seal depth (dimension D) of 50 mm in compliance with standard UNI EN 1253-1



See page 16 for our grating options

\* = These values depend on the type of grating.  
\*\* = Provided as standard

GRATING COVERS			
Standard grating	Heelsafe grating (on request)	Heavy duty ladder grating (on request)	Total Hygienic frameless grating (on request)
Mesh 25x22 **	50x11	25x8 - clear opening 20	Mesh 50x13

Other sizes

Article	DIMENSIONS IN mm						FLOW RATE lt/min	LOAD CAPACITY IN Kg	
	Ø A	Ø E	Ø B	C	D	H		CONCENTRATED LOAD	DISTRIBUTED LOAD
PGO 400 125	400	354	125	100	50	330	190	*	*
PGO 500 160	500	454	160	100	50	360	250	*	*

N.B. water seal depth (dimension D) of 50 mm in compliance with standard UNI EN 1253-1

Dimensions can be modified on request.

These technical drawings are property of INOXSYSTEM® and cannot be copied or reproduced without our prior written permission.

Modular slot channels: see page 30 for accessories,  
page 14 and 15 for gullies, page 27 for flange for waterproof membrane application.

### Dwg. 2010: STANDARD

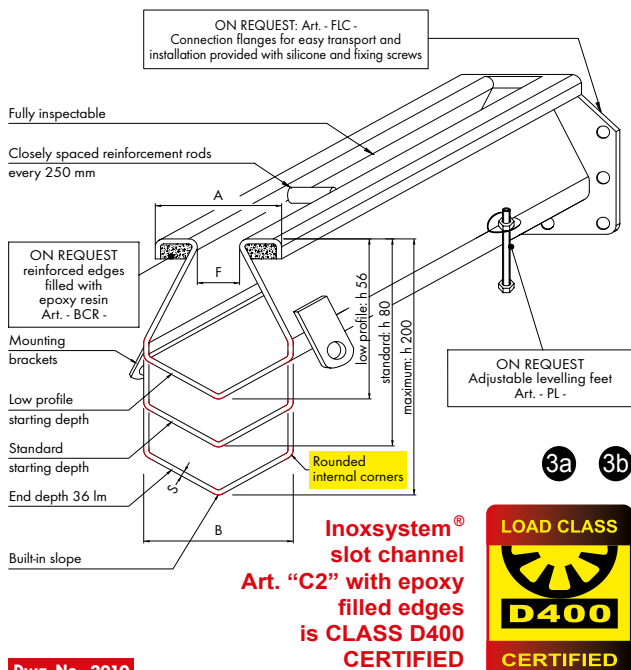

**Inoxsystem®**  
slot channel  
Art. "C2" with epoxy  
filled edges  
is CLASS D400  
CERTIFIED



#### Dwg. No. 2010

Article	S	F	A	B	Description	Load class
C1	1,5	8	50	60	Slot channel with 8 mm heelsafe slot	B125
C2	2	20	60	65	Slot channel with 20 mm standard slot	C250
C1+BCR	1,5	8	50	60	Slot channel with 8 mm heelsafe slot + epoxy filled edges	C250
C2+BCR	2	20	60	65	Slot channel with 20 mm standard slot + epoxy filled edges	D400* Certified

\* Certified up to and including D400 Load class

\*\* Although with no certification and testing, the load classes specified in the table above are guaranteed by the manufacturer  
\*\*\* Rounded internal corners for the highest hygienic performance

### Dwg. 2012: EXTRA WIDE

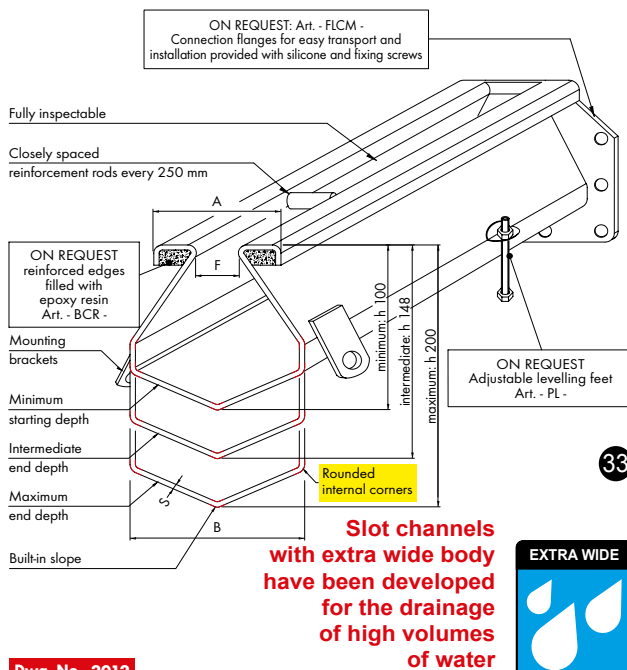

**Slot channels**  
with extra wide body  
have been developed  
for the drainage  
of high volumes  
of water



#### Dwg. No. 2012

Article	S	F	A	B	Description	Load class
MC1	1,5	8	50	100	Slot channel with 8 mm heelsafe slot and extra wide body of 100 mm	B125 Extra wide
MC2	2	20	60	100	Slot channel with 20 mm standard slot and extra wide body of 100 mm	C250 Extra wide
MC1+BCR	1,5	8	50	100	Slot channel with 8 mm heelsafe slot and extra wide body of 100 mm + epoxy filled edges	C250 Extra wide
MC2+BCR	2	20	60	100	Slot channel with 20 mm standard slot and extra wide body of 100 mm + epoxy filled edges	D400* Recommended

\* Certified up to and including D400 Load class

\*\* Although with no certification and testing, the load classes specified in the table above are guaranteed by the manufacturer  
\*\*\* Rounded internal corners for the highest hygienic performance

### INSTALLATION EXAMPLES



- SLOT WIDTH CAN BE MADE CUSTOM ON REQUEST -

- 3a Slot channel with 8 mm heelsafe slot Art. C1
- 3b Slot channel with 20 mm standard slot Art. C2
- 33 Slot channel with extra wide body of 100 mm Art. MC1 or MC2

Dimensions can be modified on request.

These technical drawings are property of INOXSYSTEM® and cannot be copied or reproduced without our prior written permission.



Modular slot channels: see page 30 for accessories,  
**page 14 and 15 for gullies, page 28 for flange for waterproof membrane application.**

### Dwg. 2013: VERTICAL EDGES

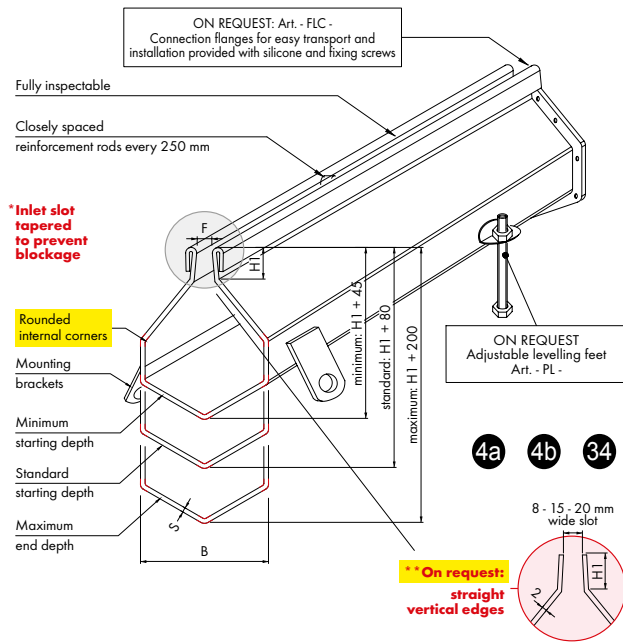

#### Dwg. No. 2013

Article	S	F	B	Description	Load class
C1BDV	1,5	8	60	Vertical straight edges channel with reduced slot anti-heel fold 8 mm	*
C2BDV	1,5	20	65	Vertical straight edges channel with standard slit pleat 20 mm	*
MC1BDV	1,5	8	100	Vertical straight edges channel with reduced slot anti-heel fold 8 mm with increased section 100 mm	*
MC2BDV	1,5	20	100	Vertical straight edges channel with standard slit pleat 20 mm with increased section 100 mm	*

H1 standard dimension is 25 mm (other dimensions on request)  
 \* Load class depends on H1 dimension  
 \*\* Rounded internal corners for the highest hygienic performance

### Dwg. 2014: LATERAL SLOT WITH VERTICAL EDGES

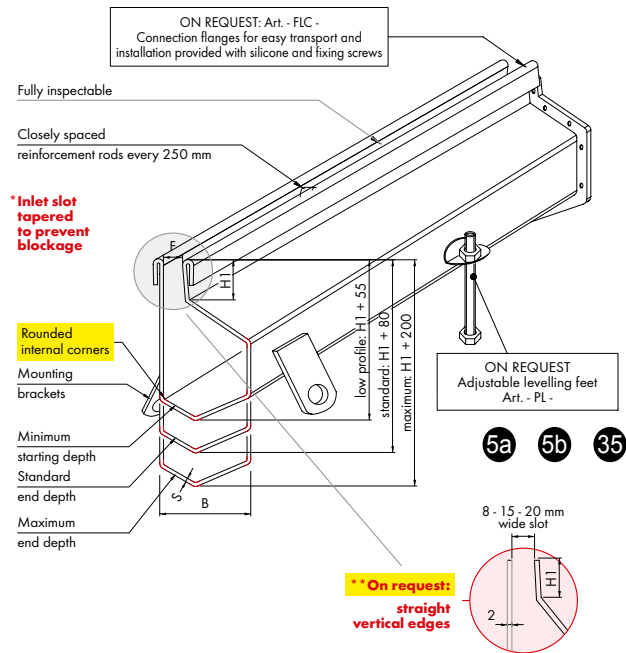

#### Dwg. No. 2014

Article	S	F	B	Description	Load class
C1BDVL	1,5	8	60	Channel with straight vertical side edges with 8 mm heel-proof reduced slot	*
C2BDVL	1,5	20	65	Channel with straight vertical side edges with standard slot fold 20 mm	*
MC1BDVL	1,5	8	100	Channel with straight vertical side edges with 8 mm heel-proof reduced slot with increased section 100 mm	*
MC2BDVL	1,5	20	100	Channel with straight vertical side edges with standard slot fold 20 mm with increased section 100 mm	*

Standard H1 dimension is 25 mm (other dimensions on request)  
 \* Load class depends on H1 dimension  
 \*\* Rounded internal corners for the highest hygienic performance

### INSTALLATION EXAMPLES



- 4a Canale a fessura 8 mm con bordi dritti verticali centrali piegasciaccia
- 4b Canale a fessura 20mm con bordi dritti verticali centrali piegasciaccia
- 34 Canale a fessura con bordi dritti verticali centrali piegasciaccia e sezione maggiorata 100 mm
- 5a Canale a fessura 8mm con bordi dritti verticali laterali piegasciaccia
- 5b Canale a fessura 20mm con bordi dritti verticali laterali piegasciaccia
- 35 Canale a fessura con bordi dritti verticali laterali piegasciaccia e sezione maggiorata 100 mm

Dimensions can be modified on request.

These technical drawings are property of INOXSYSTEM® and cannot be copied or reproduced without our prior written permission.

made of grade 304 stainless steel - grade 316 on request

### Floor drains with odor trap suitable for slot channels\*

\* suitable also for channels with grating on request (see page 16).

FLOOR DRAIN WITH VERTICAL OUTLET AND SEPARATED FILTER BASKET WITH ONE FLOOR DRAIN - CHANNEL CONNECTION

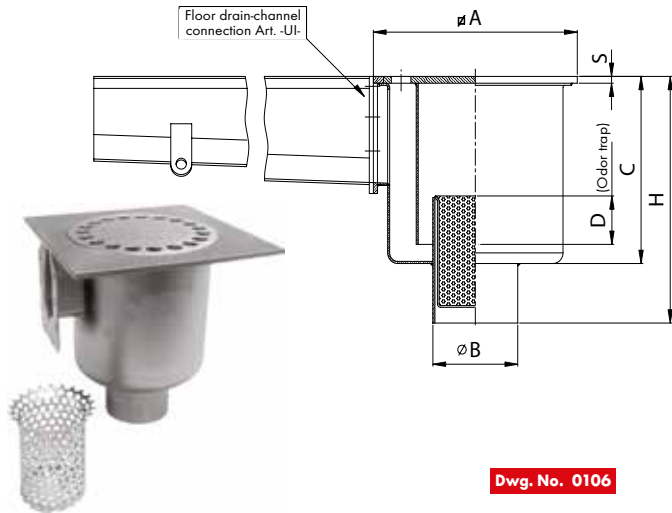

Dwg. No. 0106

Floor drains with removable odor trap available on request (see Total Hygienic catalogue)  
N.B. The floor drains heights specified in the table below are suitable for channels with maximum length 12 l/m

Article	DIMENSIONS IN mm						FLOW RATE lt/min	LOAD CAPACITY IN Kg		
	Ø A	S	Ø B	C	D	H		CONCENTRATED LOAD	DISTRIBUTED LOAD	
RCV 50 156	150	6	50	140	20	190	40	1000	10000	Ultra-low profile
RCV 63 206	200	6	63	140	20	190	60	1000	10000	Ultra-low profile
RCV 63 256	250	6	63	140	20	190	60	950	8500	Ultra-low profile
RCV 110 258	250	8	110	140	20	190	135	1000	10000	Ultra-low profile
CV 104 258	250	8	104	220	50	290	135	1200	12000	
CV 104 306	300	8	104	220	50	290	135	950	8500	
CV 110 308	300	8	110	220	50	290	135	1000	10000	Recommended
CV 160 358	350	8	160	250	50	350	220	900	8000	Deep profile

N.B. water seal depth (dimension D) of 50 mm in compliance with standard UNI EN 1253-1

FLOOR DRAIN WITH VERTICAL OUTLET AND FILTER BASKET INCORPORATED INTO THE BELL TRAP, WITH ONE FLOOR DRAIN - CHANNEL CONNECTION

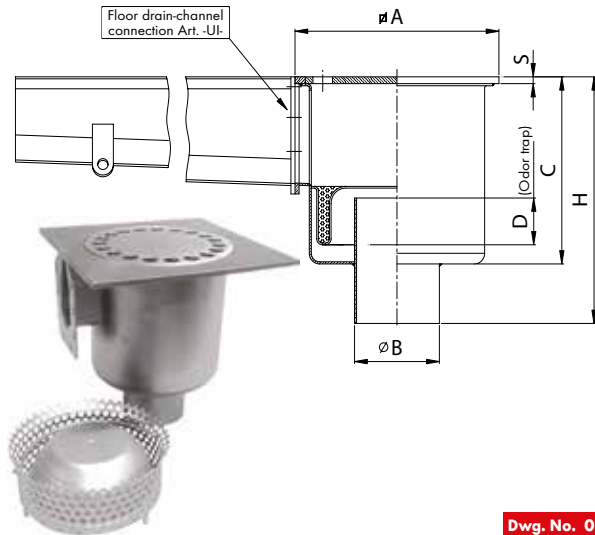

Dwg. No. 0109

Floor drains with removable odor trap available on request (see Total Hygienic catalogue)  
N.B. The floor drains heights specified in the table below are suitable for channels with maximum length 12 l/m

Article	DIMENSIONS IN mm						FLOW RATE lt/min	LOAD CAPACITY IN Kg		
	Ø A	S	Ø B	C	D	H		CONCENTRATED LOAD	DISTRIBUTED LOAD	
RCV 110 CE 258	250	8	110	140	20	190	135	1000	10000	Ultra-low profile
RCV 63 CE 308	300	8	63	140	20	190	60	1000	10000	Ultra-low profile
CV 104 CE 308	300	8	104	220	50	290	135	1000	10000	
CV 110 CE 308	300	8	110	220	50	290	135	1000	10000	Recommended
CV 160 CE 358	350	8	160	250	50	320	220	900	8000	Deep profile

N.B. water seal depth (dimension D) of 50 mm in compliance with standard UNI EN 1253-1

FLOOR DRAIN WITH HORIZONTAL OUTLET AND FILTER BASKET WITH ONE FLOOR DRAIN - CHANNEL CONNECTION

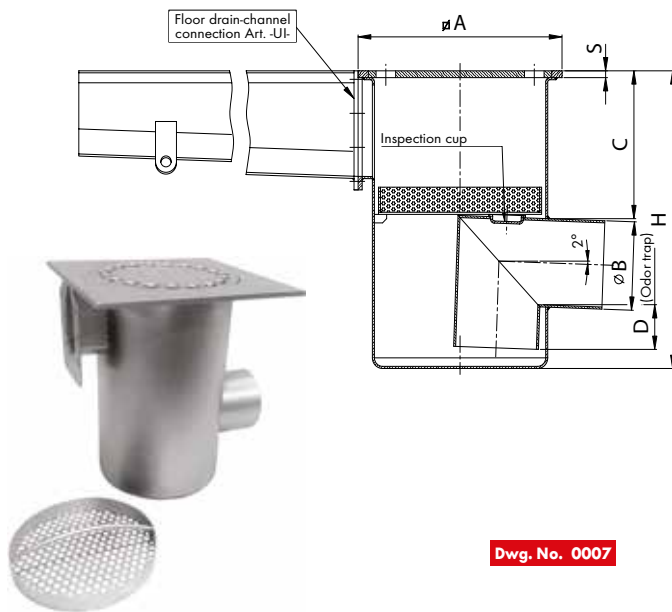

Dwg. No. 0007

N.B. The floor drains heights specified in the table below are suitable for channels with maximum length 12 l/m

Article	DIMENSIONS IN mm						FLOW RATE lt/min	LOAD CAPACITY IN Kg		
	Ø A	S	Ø B	C	D	H		CONCENTRATED LOAD	DISTRIBUTED LOAD	
CL 104 258	250	8	104	170	50	350	135	1000	10000	
CL 104 308	300	8	104	170	50	350	135	1000	10000	
CL 110 308	300	8	110	170	50	350	135	1000	10000	

N.B. water seal depth (dimension D) of 50 mm in compliance with standard UNI EN 1253-1

FLOOR DRAIN WITH HORIZONTAL OUTLET AND FILTER BASKET WITH ONE FLOOR DRAIN - CHANNEL CONNECTION

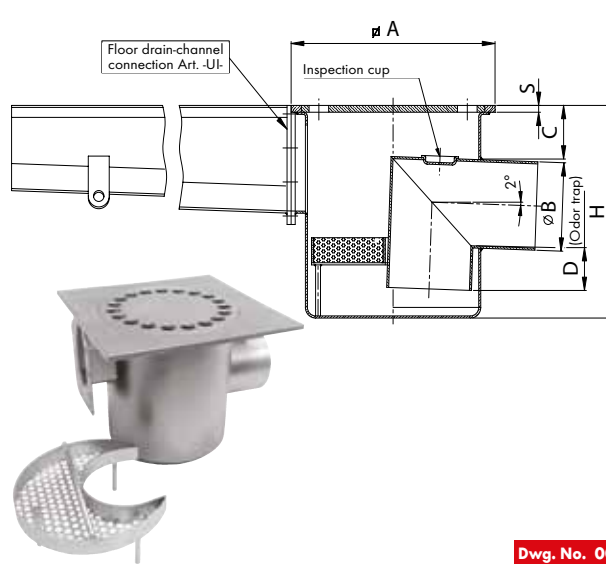

Dwg. No. 0006

N.B. The floor drains heights specified in the table below are suitable for channels with maximum length 12 l/m

Article	DIMENSIONS IN mm						FLOW RATE lt/min	LOAD CAPACITY IN Kg		
	Ø A	S	Ø B	C	D	H		CONCENTRATED LOAD	DISTRIBUTED LOAD	
CLR 50 156	150	6	50	40	15	120	40	1000	10000	Ultra-low profile
CLR 63 206	200	6	63	30	20	140	60	1000	10000	Ultra-low profile
CLR 104 258	250	8	104	50	30	220	135	1000	10000	
CLR 63 308	300	8	63	35	20	140	60	1000	10000	Ultra-low profile
CLR 104 308	300	8	104	50	30	220	135	1000	10000	
CLR 110 308	300	8	110	50	30	220	135	1000	10000	Recommended
CLR 160 358	350	8	160	50	40	300	220	900	8000	Deep profile

N.B. water seal depth (dimension D) of 50 mm in compliance with standard UNI EN 1253-1

See page 32 lines 1050, 1060 and 1070

Dimensions can be modified on request.

These technical drawings are property of INOXSYSTEM® and cannot be copied or reproduced without our prior written permission.



### Gullies suitable for slot channels\*

GULLY WITH GRATING WITH VERTICAL OUTLET AND FILTER BASKET, WITH ONE GULLY - CHANNEL CONNECTION

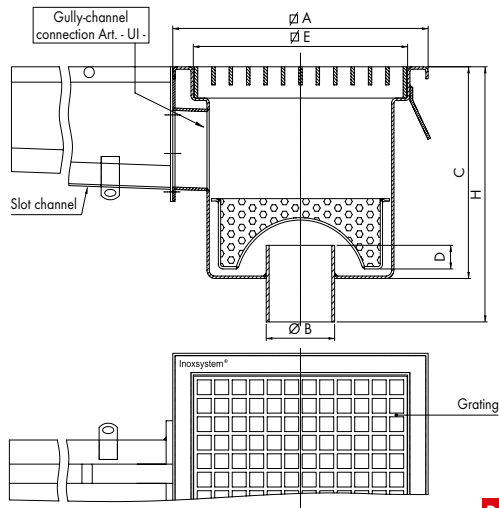

Dwg. No. 0309

GRATING COVERS			
Standard grating	Heelsafe grating (on request)	Heavy duty ladder grating (on request)	Total Hygienic frameless grating (on request)
Mesh 25x22 **	50x11	25x8 - clear opening 20	Mesh 50x13

\* = These values depend on the type of grating

\*\* = Supplied as Standard

Article	DIMENSIONS IN mm						FLOW RATE l <sub>t</sub> /min	LOAD CAPACITY IN Kg	
	∅ A	∅ E	∅ B	C	D	H		CONCENTRATED LOAD	DISTRIBUTED LOAD
R CGV 300 63	300	250	63	140	25	200	50	*	*
R CGV 400 63	400	350	63	140	25	200	50	*	*
R CGV 500 63	500	450	63	140	25	200	50	*	*
CGV 300 110	300	250	110	220	50	290	135	*	*
CGV 400 110	400	350	110	220	50	290	135	*	*
CGV 500 110	500	450	110	220	50	290	135	*	*

Dimensions can be customized on request.

N.B. water seal depth (dimension D) of 50 mm in compliance with standard UNI EN 1253-1

See page 32 line 1250

GULLY WITH GRATING WITH HORIZONTAL OUTLET AND FILTER BASKET, WITH ONE GULLY - CHANNEL CONNECTION

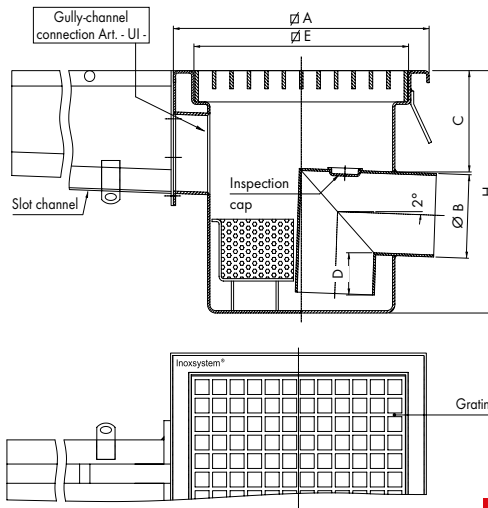

Dwg. No. 0306

GRATING COVERS			
Standard grating	Heelsafe grating (on request)	Heavy duty ladder grating (on request)	Total Hygienic frameless grating (on request)
Mesh 25x22 **	50x11	25x8 - clear opening 20	Mesh 50x13

\* = These values depend on the type of grating

\*\* = Supplied as Standard

Article	DIMENSIONS IN mm						FLOW RATE l <sub>t</sub> /min	LOAD CAPACITY IN Kg	
	∅ A	∅ E	∅ B	C	D	H		CONCENTRATED LOAD	DISTRIBUTED LOAD
R CGL 300 63	300	250	63	37	20	140	50	*	*
R CGL 400 63	400	350	63	37	20	140	50	*	*
R CGL 500 63	500	450	63	37	20	140	50	*	*
CGL 300 110	300	250	110	50	50	220	135	*	*
CGL 400 110	400	350	110	50	50	220	135	*	*
CGL 500 110	500	450	110	50	50	220	135	*	*

Dimensions can be customized on request.

N.B. water seal depth (dimension D) of 50 mm in compliance with standard UNI EN 1253-1

See page 32 line 1250

ACCESS UNIT WITH BLIND COVER, VERTICAL DIRECT OUTLET AND FILTER BASKET, WITH ONE GULLY-CHANNEL CONNECTION

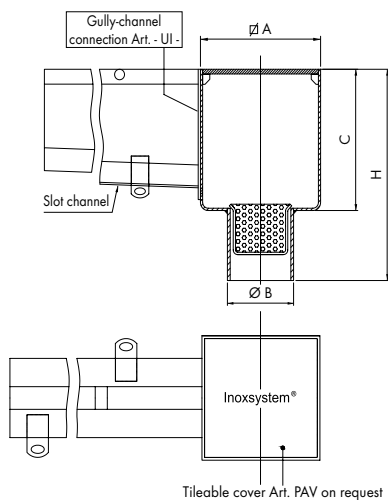

\* On request the access unit cover should be tileable or with central slot for non-stop slot effect

Dwg. No. 0319

Article	DIMENSIONS IN mm				FLOW RATE l <sub>t</sub> /min	LOAD CAPACITY IN Kg	
	∅ A	∅ B	C	H		CONCENTRATED LOAD	DISTRIBUTED LOAD
CCV 80	80	63	100	160	120	*	*
CCV 100	100	75	100	160	150	*	*
** CCV 156	150	110	100	160	250	*	*

Dimensions can be customized on request.

\*\* = Article CCV 156 is provided with perforated cover.

See from page 33 to 37 line 1150 - 1470 - 1480 - 1670 - 1680

ACCESS UNIT WITH BLIND COVER, HORIZONTAL DIRECT OUTLET AND FILTER BASKET, WITH ONE GULLY-CHANNEL CONNECTION

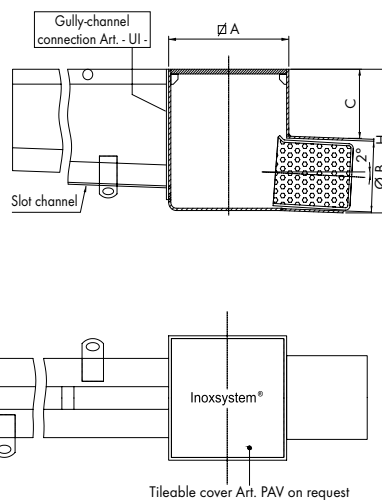

\* On request the access unit cover should be tileable or with central slot for non-stop slot effect

Dwg. No. 0316

Article	DIMENSIONS IN mm				FLOW RATE l <sub>t</sub> /min	LOAD CAPACITY IN Kg	
	∅ A	∅ B	C	H		CONCENTRATED LOAD	DISTRIBUTED LOAD
CCL 80	80	63	37	100	120	*	*
CCL 100	100	75	35	110	150	*	*
** CCL 156	150	110	40	150	250	*	*

\*\* = Article CCL 156 is provided with perforated cover.

See from page 33 to 37 line 1150 - 1470 - 1480 - 1670 - 1680

made of grade 304 stainless steel - grade 316 on request

Modular channels with grating: see page 30 for accessories,  
page 17 for gullies, pages 27 and 28 for flange for waterproof membrane application.

### Dwg. 0901: CHANNELS WITH GRATING

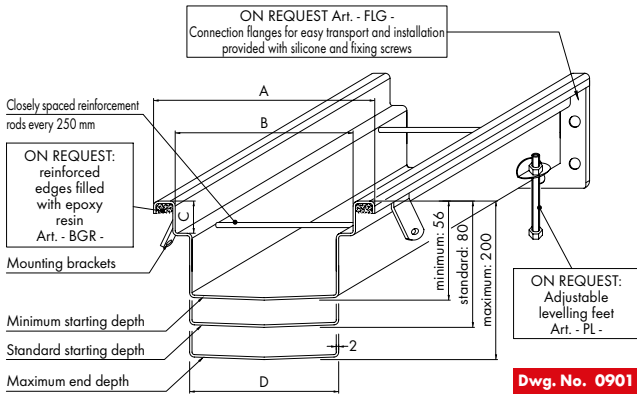

Dwg. No. 0901

\* = these values depend on the type of grating

Article	DIMENSIONS in mm			
S= mm 2	A	B	C	D
STANDARD				
CGS 100 25 (see note **)	100	67	26*	60
CGS 150 25	150	104	26*	70
CGS 200 25	200	154	26*	120
CGS 225 25	225	190	26*	160
CGS 250 25	250	204	26*	170
CGS 300 25	300	254	26*	220
CGS 350 25	350	304	26*	270
CGS 400 25	400	354	26*	320
CGS 450 25	450	404	26*	370
CGS 500 25	500	454	26*	420

\*\* = Inoxsystem Total hygienic channel (see page 48) but with standard grating mesh 25x22 h 25 mm

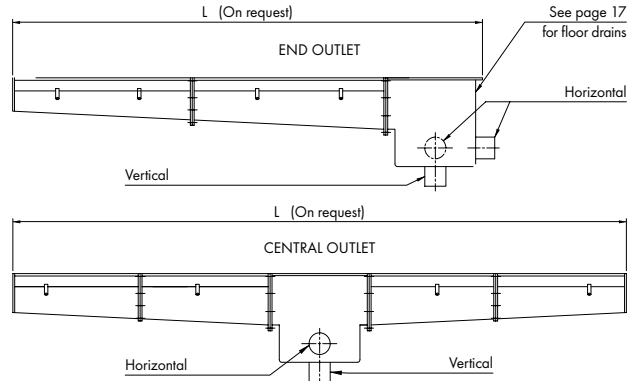

- Built-in slope 4 mm/m.
- Closely spaced reinforcement rods.
- Mounting brackets.
- On request: connection flanges (every 3 or 6 m) for easy transport and installation (Art. - FLG -) see catalogue page 30.
- On request: reinforced edges filled with epoxy resin (Art. - BGR -) see catalogue page 3 and 30.
- On request: adjustable levelling feet (Art. - PLG -) see catalogue page 30.
- On request: 1/2" inlet socket to let water flush and clean the drain (Art. - IL -).

**N.B.**

1e - Closed grating with double slot

1d - Heavy duty ladder grating

1c - Heelsafe

1b - Antislip

1a - Standard

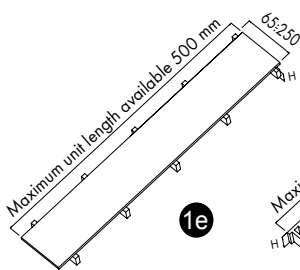

Dwg. No. 0855

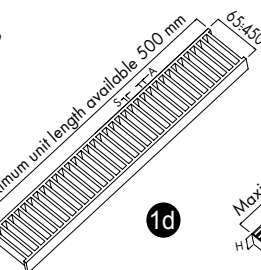

Dwg. No. 0851

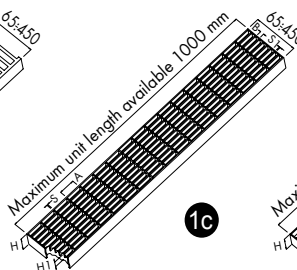

Dwg. No. 0854

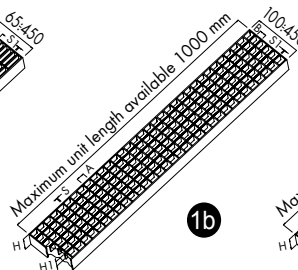

Dwg. No. 0858

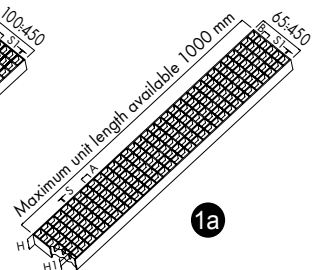

Dwg. No. 0853

Plate thk	Bearing bar	Slot	H
6 mm	20x8	10 mm	25

Edge bar	Bearing bar HxS	Clear opening A	H
25x8	25x8	20	25

Mesh AxB	Bearing bar HxS	Cross bar H1X51
50x11 (Antiatcco)	25x2	10x2

Mesh AxB	Bearing bar HxS	Cross bar H1X51
25x22 (Std)	25x2	10x2

Mesh AxB	Bearing bar HxS	Cross bar H1X51
25x22 (Std)	25x2	10x2

### INSTALLATION EXAMPLES

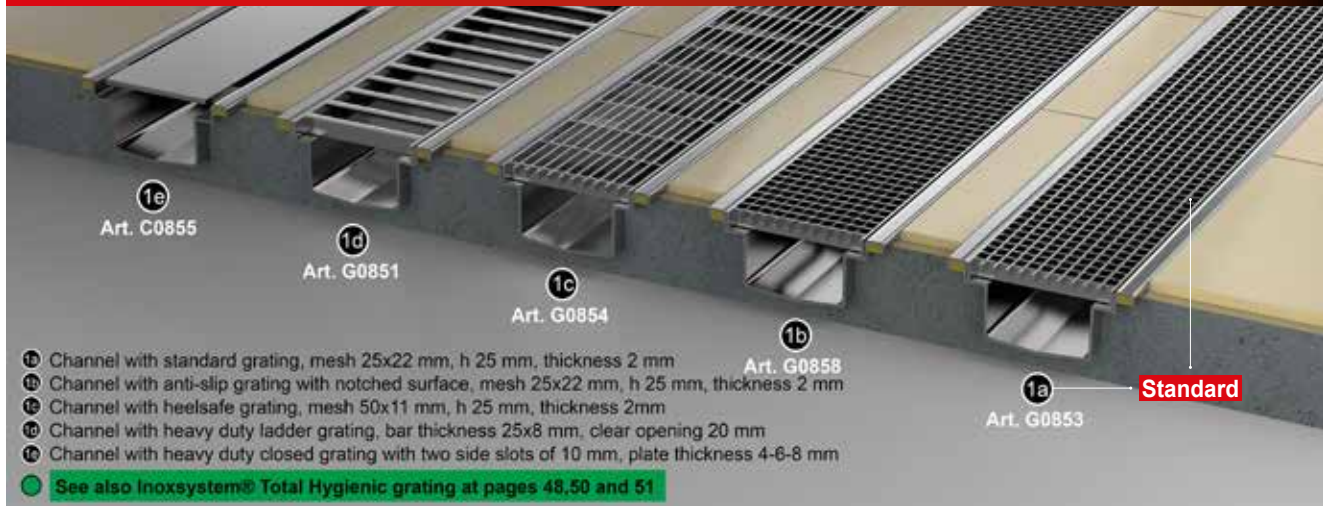

- 1e Channel with standard grating, mesh 25x22 mm, h 25 mm, thickness 2 mm Art. G0853
- 1d Channel with anti-slip grating with notched surface, mesh 25x22 mm, h 25 mm, thickness 2 mm Art. G0858
- 1c Channel with heelsafe grating, mesh 50x11 mm, h 25 mm, thickness 2mm Art. G0854
- 1b Channel with heavy duty ladder grating, bar thickness 25x8 mm, clear opening 20 mm Art. G0851
- 1a Channel with heavy duty closed grating with two side slots of 10 mm, plate thickness 4-6-8 mm Art. G0855

See also Inoxsystem® Total Hygienic grating at pages 48, 50 and 51

Dimensions can be modified on request.

These technical drawings are property of INOXSYSTEM® and cannot be copied or reproduced without our prior written permission.



ROUND BODY GULLY WELDED TO THE CHANNEL BODY WITH FILTER BASKET INCORPORATED INTO THE BELL TRAP AND VERTICAL OUTLET

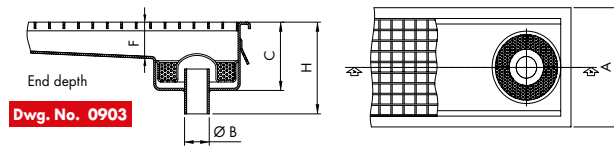

Dwg. No. 0903

Article (Gully)	Dimensions in mm			
	A	Ø B	C	H
PCTV 63	100	/	/	/
	150	/	/	/
	200	63	F+60	C+60
	250	63	F+60	C+60
	300	63	F+60	C+60
	350	63	F+60	C+60
	400	63	F+60	C+60
	450	63	F+60	C+60
	500	63	F+60	C+60

Article (Gully)	Dimensions in mm			
	A	Ø B	C	H
PCTV 110	100	/	/	/
	150	/	/	/
	200	/	/	/
	250	/	/	/
	300	110	F+60	C+60
	350	110	F+60	C+60
	400	110	F+60	C+60
	450	110	F+60	C+60
	500	110	F+60	C+60

See page 34 line 0910

ROUND BODY GULLY WELDED TO THE CHANNEL BODY WITH FILTER BASKET AND HORIZONTAL OUTLET

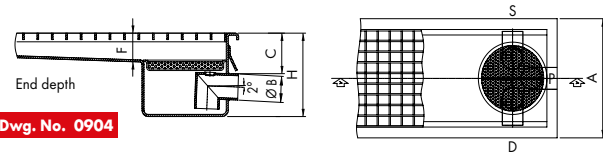

Dwg. No. 0904

Article (Gully)	Dimensions in mm			
	A	Ø B	C	H
PCTO 63	100	/	/	/
	150	/	/	/
	200	63	F+20	F+100
	250	63	F+20	F+100
	300	63	F+20	F+100
	350	63	F+20	F+100
	400	63	F+20	F+100
	450	63	F+20	F+100
	500	63	F+20	F+100

Article (Gully)	Dimensions in mm			
	A	Ø B	C	H
PCTO 110	100	/	/	/
	150	/	/	/
	200	/	/	/
	250	/	/	/
	300	110	F+20	F+210
	350	110	F+20	F+210
	400	110	F+20	F+210
	450	110	F+20	F+210
	500	110	F+20	F+210

See page 34 line 0910

SQUARE BODY GULLY WELDED TO THE CHANNEL BODY WITH FILTER BASKET INCORPORATED INTO THE BELL TRAP AND VERTICAL OUTLET

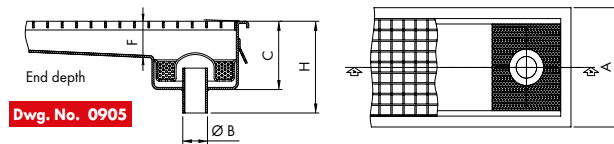

Dwg. No. 0905

Article (Gully)	Dimensions in mm			
	A	Ø B	C	H
PCSV 63 / PCSV 110	100	/	/	/
	150	63	F+60	C+60
	200	110	F+60	C+60
	250	110	F+60	C+60

See page 34 line 0920

SQUARE BODY GULLY WELDED TO THE CHANNEL BODY WITH FILTER BASKET AND HORIZONTAL OUTLET

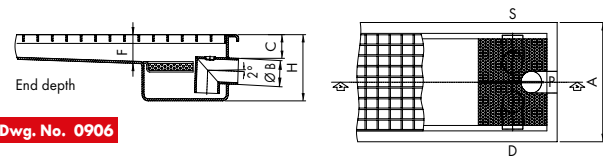

Dwg. No. 0906

Article (Floor drain)	Dimensions in mm			
	A	Ø B	C	H
PCSO63	100	/	/	/
	150	63	35	140
	200	63	35	140
	250	63	35	140
	300	63	35	140
	350	63	35	140
	400	63	35	140
	450	63	35	140
	500	63	35	140

Article (Floor drain)	Dimensions in mm			
	A	Ø B	C	H
PCSO110	100	/	/	/
	150	/	/	/
	200	110	50	220
	250	110	50	220
	300	110	50	220
	350	110	50	220
	400	110	50	220
	450	110	50	220
	500	110	50	220

See page 34 line 0920

FLOOR DRAIN WITH SQUARE TOP COVER, VERTICAL OUTLET AND FILTER BASKET INCORPORATED INTO THE BELL TRAP, PROVIDED WITH ONE FLOOR DRAIN-CHANNEL CONNECTION

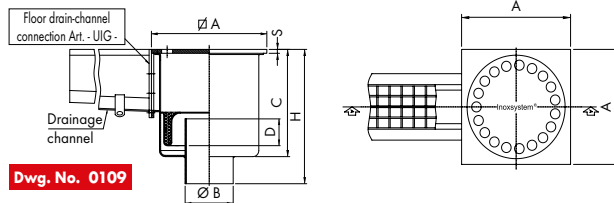

Dwg. No. 0109

Article	DIMENSIONS IN mm							FLOW RATE lt/min	LOAD CAPACITY IN Kg	
	Ø A	S	Ø B	C	D	H	CONCENTRATED LOAD		DISTRIBUTED LOAD	
RCV 110 CE 258	250	8	110	140	20	190	135	1000	10000	
RCV 63 CE 308	300	8	63	140	20	190	50	1000	10000	
CV 104 CE 308	300	8	104	220	50	290	135	1000	10000	
CV 110 CE 308	300	8	110	220	50	290	135	1000	10000	
CV 160 CE 358	350	8	160	250	50	320	220	900	8000	

See page 34 line 2050

N.B. water seal depth (dimension D) of 50 mm in compliance with standard UNI EN 1253-1

FLOOR DRAIN WITH SQUARE TOP COVER, HORIZONTAL OUTLET AND FILTER BASKET, PROVIDED WITH ONE FLOOR DRAIN-CHANNEL CONNECTION

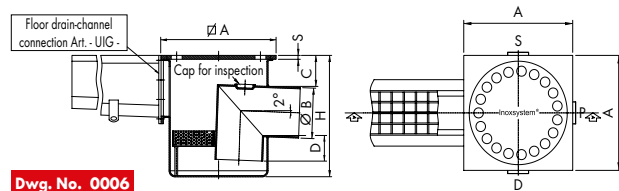

Dwg. No. 0006

Article	DIMENSIONS IN mm							FLOW RATE lt/min	LOAD CAPACITY IN Kg	
	Ø A	S	Ø B	C	D	H	CONCENTRATED LOAD		DISTRIBUTED LOAD	
CLR 50 156	150	6	50	40	15	120	40	1000	10000	
CLR 63 206	200	6	63	30	20	140	50	1000	10000	
CLR 104 258	250	8	104	50	30	220	135	1000	10000	
CLR 63 308	300	8	63	35	20	140	50	1000	10000	
CLR 104 308	300	8	104	50	30	220	135	1000	10000	
CLR 110 308	300	8	110	50	30	220	135	1000	10000	
CLR 160 358	350	8	160	50	40	300	220	900	8000	

See page 34 line 2050

GULLY WITH GRATING, VERTICAL OUTLET AND FILTER BASKET INCORPORATED INTO THE BELL TRAP, PROVIDED WITH ONE GULLY-CHANNEL CONNECTION

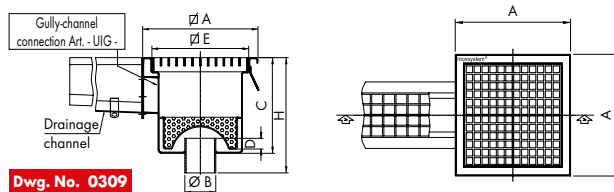

Dwg. No. 0309

Article	DIMENSIONS IN mm							FLOW RATE lt/min	LOAD CAPACITY IN Kg	
	Ø A	Ø E	Ø B	C	D	H	CONCENTRATED LOAD		DISTRIBUTED LOAD	
R CGV 300 63	300	250	63	140	25	200	50	*	*	
R CGV 400 63	400	350	63	140	25	200	50	*	*	
R CGV 500 63	500	450	63	140	25	200	50	*	*	
CGV 300 110	300	250	110	220	50	290	135	*	*	
CGV 400 110	400	350	110	220	50	290	135	*	*	
CGV 500 110	500	450	110	220	50	290	135	*	*	

See page 34 line 2150

N.B. water seal depth (dimension D) of 50 mm in compliance with standard UNI EN 1253-1

GULLY WITH GRATING, HORIZONTAL OUTLET AND FILTER BASKET, PROVIDED WITH ONE GULLY-CHANNEL CONNECTION

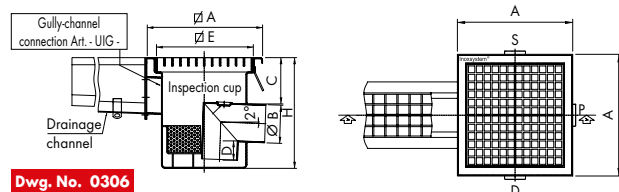

Dwg. No. 0306

Article	DIMENSIONS IN mm							FLOW RATE lt/min	LOAD CAPACITY IN Kg	
	Ø A	Ø E	Ø B	C	D	H	CONCENTRATED LOAD		DISTRIBUTED LOAD	
R CGL 300 63	300	250	63	37	20	140	50	*	*	
R CGL 400 63	400	350	63	37	20	140	50	*	*	
R CGL 500 63	500	450	63	37	20	140	50	*	*	
CGL 300 110	300	250	110	50	50	220	135	*	*	
CGL 400 110	400	350	110	50	50	220	135	*	*	
CGL 500 110	500	450	110	50	50	220	135	*	*	

See page 34 line 2150

N.B. water seal depth (dimension D) of 50 mm in compliance with standard UNI EN 1253-1

Dimensions can be modified on request.

These technical drawings are property of INOXSYSTEM® and cannot be copied or reproduced without our prior written permission.

made of grade 304 stainless steel - grade 316 on request

### Drainage systems - Standard gullies and channels with grating.

STAINLESS STEEL GULLIES WITH GRATING AND REMOVABLE FILTER BASKET  
VERTICAL OUTLET WITH ODOR TRAP

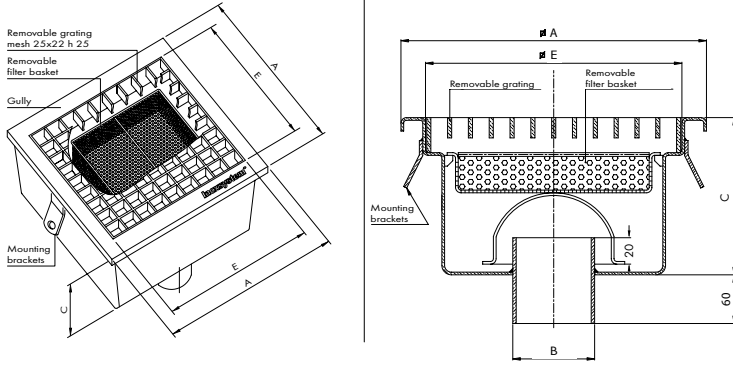

ARTICLE	A	E	Ø B	C
PGV 200 50	200	150	50	110
PGV 300 50	300	250	50	110
PGV 400 50	400	350	50	110
PGV 500 50	500	450	50	110

Dimensions in mm

\* Low profile version

ARTICLE	A	E	Ø B	C
PGV 200 63	200	150	63	110
PGV 300 63	300	250	63	110
PGV 400 63	400	350	63	110
PGV 500 63	500	450	63	110

Dimensions in mm

\* Low profile version

IDEAL FOR PROFESSIONAL KITCHENS  
AND FOOD PROCESSING FACILITIES



Dwg. No. 0512

See  
page 11  
for similar  
products

art. PGV .....

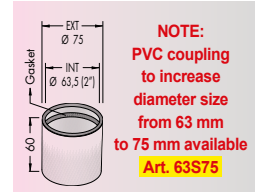

NOTE:  
PVC coupling  
to increase  
diameter size  
from 63 mm  
to 75 mm available  
Art. 63S75

STAINLESS STEEL CHANNELS WITH GRATING AND REMOVABLE FILTER BASKET  
CENTRAL VERTICAL OUTLET WITH ODOR TRAP

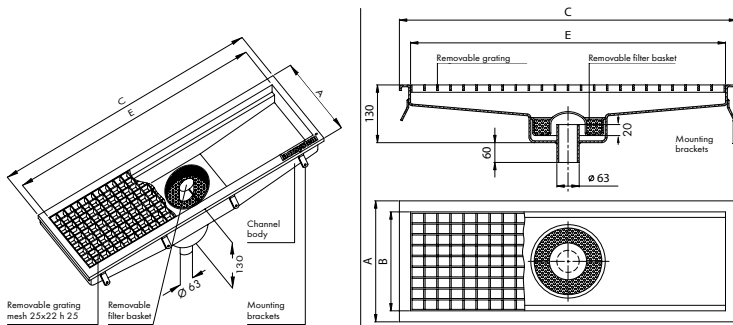

ARTICLE	A	B	C	E	ARTICLE	A	B	C	E	ARTICLE	A	B	C	E
CGV 20 105	200	150	1050	1000	CGV 20 205	200	150	2050	2000	CGV 20 305	200	150	3050	3000
CGV 30 105	300	250	1050	1000	CGV 30 205	300	250	2050	2000	CGV 30 305	300	250	3050	3000
CGV 40 105	400	350	1050	1000	CGV 40 205	400	350	2050	2000	CGV 40 305	400	350	3050	3000
CGV 50 105	500	450	1050	1000	CGV 50 205	500	450	2050	2000	CGV 50 305	500	450	3050	3000

Dimensions in mm

Available with square body gully  
and customized dimensions  
See page 34 line 0920



Dwg. No. 0912

See  
page 34  
line 0910

art. CGV .....

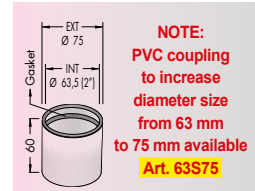

NOTE:  
PVC coupling  
to increase  
diameter size  
from 63 mm  
to 75 mm available  
Art. 63S75

STAINLESS STEEL CHANNELS WITH GRATING AND REMOVABLE FILTER BASKET  
END VERTICAL OUTLET WITH ODOR TRAP

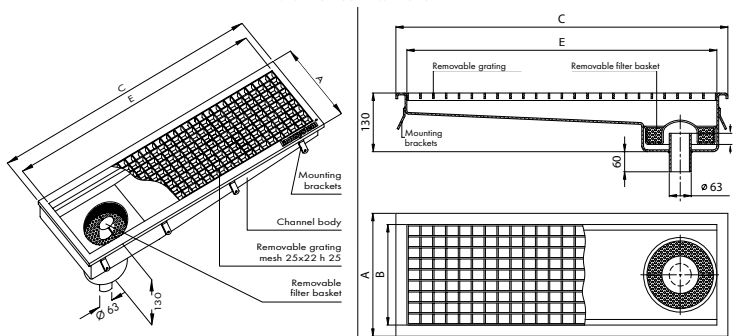

ARTICLE	A	B	C	E	ARTICLE	A	B	C	E	ARTICLE	A	B	C	E
CGVT 20 105	200	150	1050	1000	CGVT 20 205	200	150	2050	2000	CGVT 20 305	200	150	3050	3000
CGVT 30 105	300	250	1050	1000	CGVT 30 205	300	250	2050	2000	CGVT 30 305	300	250	3050	3000
CGVT 40 105	400	350	1050	1000	CGVT 40 205	400	350	2050	2000	CGVT 40 305	400	350	3050	3000
CGVT 50 105	500	450	1050	1000	CGVT 50 205	500	450	2050	2000	CGVT 50 305	500	450	3050	3000

Dimensions in mm

Available with square body gully  
and customized dimensions  
See page 34 line 0920



Dwg. No. 0913

See  
page 34  
line 0910

art. CGVT .....

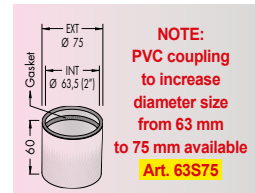

NOTE:  
PVC coupling  
to increase  
diameter size  
from 63 mm  
to 75 mm available  
Art. 63S75

- N.B.**
- Available with direct outlet (no odor trap, no filter basket).
  - Custom made dimensions on request.
  - Other diameter sizes and heights on request.
  - On request 1/2" inlet socket to let water flush in and clean the drain (Art. - IL - see page 30).

Dimensions can be modified on request.

These technical drawings are property of INOXSYSTEM® and cannot be copied or reproduced without our prior written permission.



made of grade 304 stainless steel - grade 316 on request

## Drainage systems - Standard gullies and channels with grating.

IDEAL FOR PROFESSIONAL KITCHENS  
AND FOOD PROCESSING FACILITIES

STAINLESS STEEL GULLIES WITH GRATING AND REMOVABLE FILTER BASKET  
HORIZONTAL OUTLET WITH ODOR TRAP

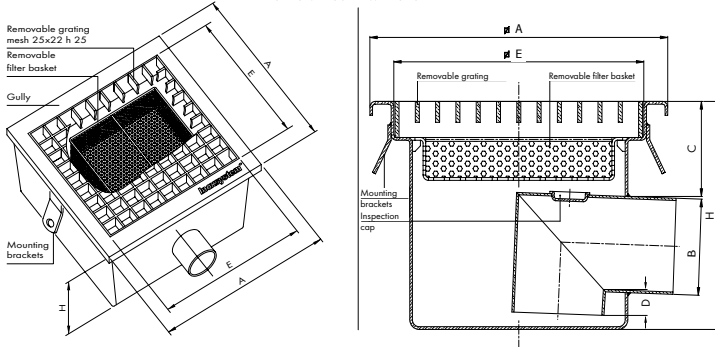

ARTICLE	A	E	Ø B	C	D	H
PGO 200 50	200	150	50	35	15	110
PGO 300 50	300	250	50	35	15	110
PGO 400 50	400	350	50	35	15	110
PGO 500 50	500	450	50	35	15	110

Dimensions in mm

ARTICLE	A	E	Ø B	C	D	H
PGO 200 63	200	150	63	50	20	150
PGO 300 63	300	250	63	50	20	150
PGO 400 63	400	350	63	50	20	150
PGO 500 63	500	450	63	50	20	150

Dimensions in mm

\* Low profile version



Dwg. No. 0412

art. PGO .....

See  
page 11  
for similar  
products

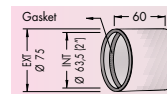

NOTE:  
PVC coupling to increase diameter  
size from 63 mm to 75 mm available  
Art. 63S75

STAINLESS STEEL CHANNELS WITH GRATING AND REMOVABLE FILTER BASKET  
CENTRAL HORIZONTAL OUTLET WITH ODOR TRAP

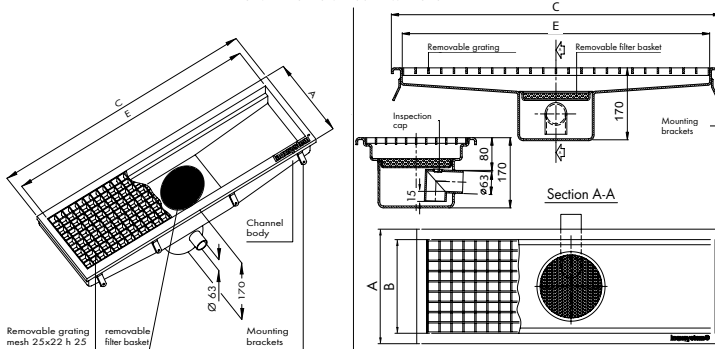

ARTICLE	A	B	C	E
CGO 20 105	200	150	1050	1000
CGO 30 105	300	250	1050	1000
CGO 40 105	400	350	1050	1000
CGO 50 105	500	450	1050	1000

Dimensions in mm

ARTICLE	A	B	C	E
CGO 20 205	200	150	2050	2000
CGO 30 205	300	250	2050	2000
CGO 40 205	400	350	2050	2000
CGO 50 205	500	450	2050	2000

Dimensions in mm

ARTICLE	A	B	C	E
CGO 20 305	200	150	3050	3000
CGO 30 305	300	250	3050	3000
CGO 40 305	400	350	3050	3000
CGO 50 305	500	450	3050	3000

Dimensions in mm

Available with square body gully  
and customized dimensions  
See page 34 line 0920



Dwg. No. 0914

art. CGO .....

See  
page 34  
line 0910

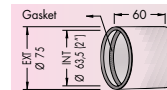

NOTE:  
PVC coupling to increase diameter  
size from 63 mm to 75 mm available  
Art. 63S75

STAINLESS STEEL CHANNELS WITH GRATING AND REMOVABLE FILTER BASKET  
END HORIZONTAL OUTLET WITH ODOR TRAP

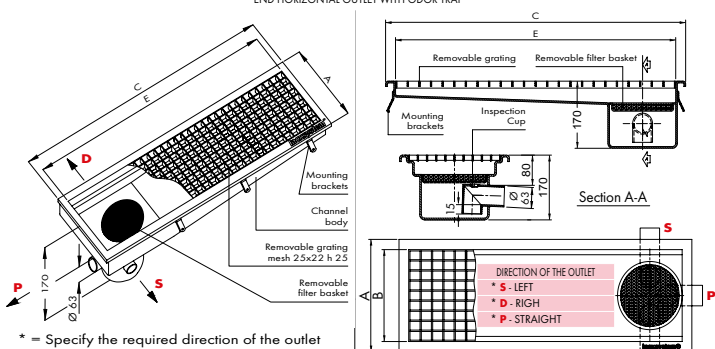

\* = Specify the required direction of the outlet  
(ex. CGOT 30 105 P)

ARTICLE	A	B	C	E
CGOT 20 105	200	150	1050	1000
CGOT 30 105	300	250	1050	1000
CGOT 40 105	400	350	1050	1000
CGOT 50 105	500	450	1050	1000

Dimensions in mm

ARTICLE	A	B	C	E
CGOT 20 205	200	150	2050	2000
CGOT 30 205	300	250	2050	2000
CGOT 40 205	400	350	2050	2000
CGOT 50 205	500	450	2050	2000

Dimensions in mm

ARTICLE	A	B	C	E
CGOT 20 305	200	150	3050	3000
CGOT 30 305	300	250	3050	3000
CGOT 40 305	400	350	3050	3000
CGOT 50 305	500	450	3050	3000

Dimensions in mm

Available with square body gully  
and customized dimensions  
See page 34 line 0920



Dwg. No. 0915

art. CGOT .....

See  
page 34  
line 0910

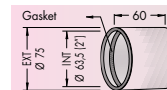

NOTE:  
PVC coupling to increase diameter  
size from 63 mm to 75 mm available  
Art. 63S75

**N.B.**

- Available with direct outlet (no odor trap, no filter basket).
- Custom made dimensions on request.
- Other diameter sizes and heights on request.
- On request 1/2" inlet socket to let water flush in and clean the drain (art. -IL see page 30).

Dimensions can be modified on request.

These technical drawings are property of INOXSYSTEM® and cannot be copied or reproduced without our prior written permission.

made of stainless steel, sheet thickness 2 mm, provided with floor drain with 8 mm thick square top plate, odor trap and filter basket - AISI 304 - AISI 316 on request

### Drainage systems - Slot channels with standard slot.

IDEAL FOR PROFESSIONAL KITCHENS AND FOOD PROCESSING FACILITIES

STAINLESS STEEL SLOT CHANNELS WITH ODOR TRAP AND REMOVABLE FILTER BASKET  
CENTRAL VERTICAL OUTLET

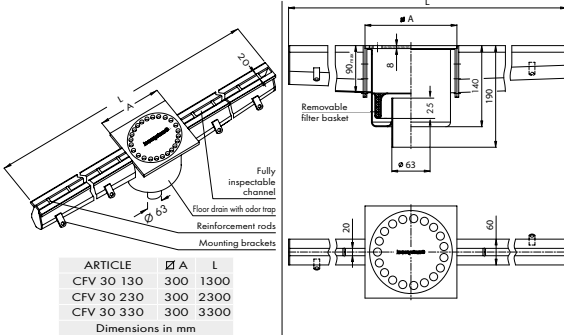

Dwg. No. 1053

See page 32 line 1050

art. CFV .....

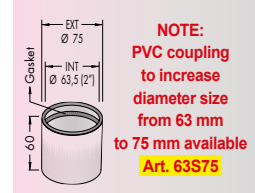

STAINLESS STEEL SLOT CHANNELS WITH ODOR TRAP AND REMOVABLE FILTER BASKET  
END VERTICAL OUTLET

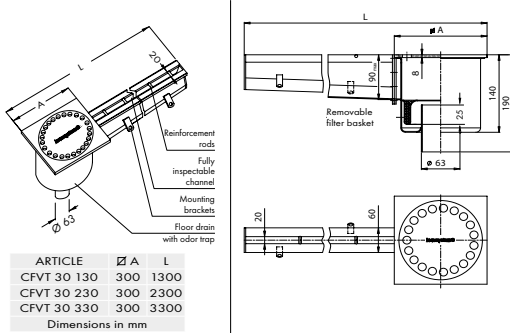

Dwg. No. 1054

See page 32 line 1050

art. CFVT .....

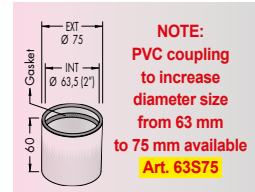

STAINLESS STEEL SLOT CHANNELS WITH ODOR TRAP AND REMOVABLE FILTER BASKET  
CENTRAL HORIZONTAL OUTLET

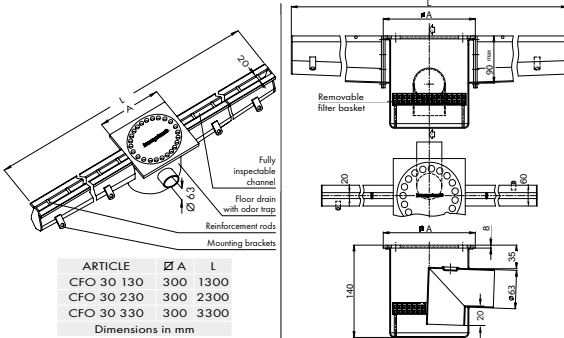

Dwg. No. 1051

See page 32 line 1050

art. CFO .....



STAINLESS STEEL SLOT CHANNELS WITH ODOR TRAP AND REMOVABLE FILTER BASKET  
END HORIZONTAL OUTLET

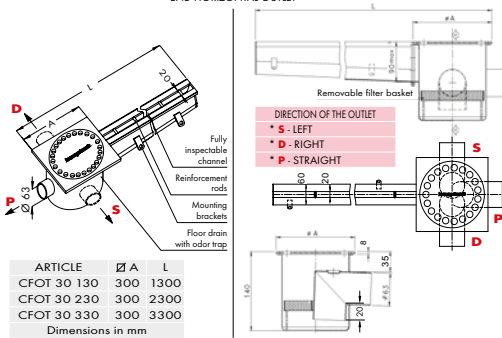

Direction of the outlet in the picture: "P" (Straight)

Dwg. No. 1052

See page 32 line 1050

art. CFOT .....



Specify the required direction of the outlet (ex. CFOT 30 130 P)

- N.B.**
- On request these lines should be provided with the floor drains described at page 14 and 15.
  - Available with direct outlet (no odor trap, no filter basket).
  - Custom made dimensions on request.
  - Other diameter sizes and heights on request.
  - On request 1/2" inlet socket to let water flush in and clean the drain (art. 4L see page 30).

Dimensions can be modified on request.

These technical drawings are property of INOXSYSTEM® and cannot be copied or reproduced without our prior written permission.



made of stainless steel, sheet thickness 1,5 mm, provided with access unit with direct outlet and filter basket - AISI 304 - AISI 316 on request

### Drainage systems - Slot channels with heelsafe slot.

IDEAL FOR SWIMMING POOLS, SHOWERS AND TERRACES

STAINLESS STEEL CHANNELS WITH HEELSAFE SLOT AND INSPECTION UNIT WITH CENTRAL VERTICAL DIRECT OUTLET AND REMOVABLE FILTER BASKET

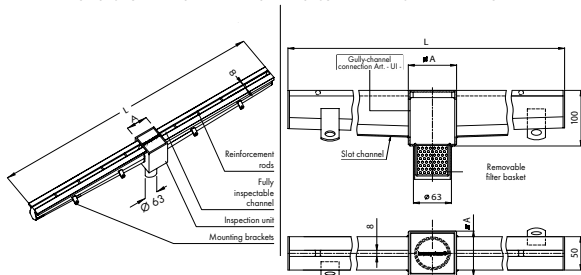

ARTICLE	Ø A	L
CRV 8108	80	1080
CRV 8208	80	2080
CRV 8308	80	3080

Dimensions in mm

Dwg. No. 1153

See page 33 line 1150

art. CRV .....

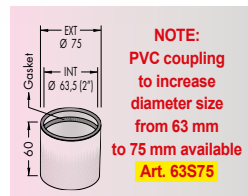

STAINLESS STEEL CHANNELS WITH HEELSAFE SLOT AND INSPECTION UNIT WITH END VERTICAL DIRECT OUTLET AND REMOVABLE FILTER BASKET

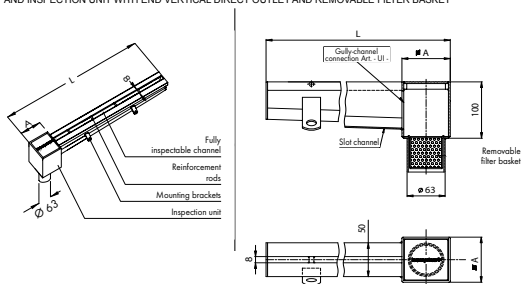

ARTICLE	Ø A	L
CRVT 8108	80	1080
CRVT 8208	80	2080
CRVT 8308	80	3080

Dimensions in mm

Dwg. No. 1154

See page 33 line 1150

art. CRVT .....

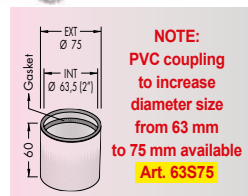

STAINLESS STEEL CHANNELS WITH HEELSAFE SLOT AND INSPECTION UNIT WITH CENTRAL HORIZONTAL DIRECT OUTLET AND REMOVABLE FILTER BASKET

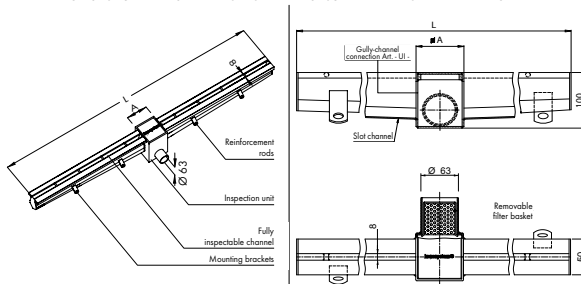

ARTICLE	Ø A	L
CRO 8108	80	1080
CRO 8208	80	2080
CRO 8308	80	3080

Dimensions in mm

Dwg. No. 1151

See page 33 line 1150

art. CRO .....



STAINLESS STEEL CHANNELS WITH HEELSAFE SLOT AND INSPECTION UNIT WITH END HORIZONTAL DIRECT OUTLET AND REMOVABLE FILTER BASKET

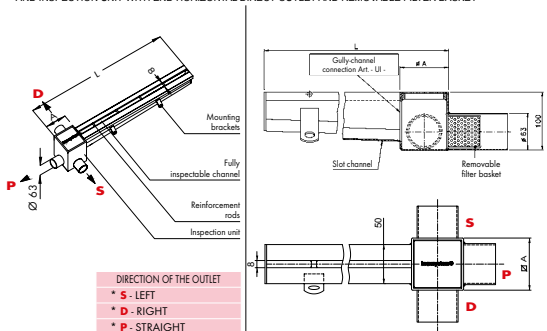

ARTICLE	Ø A	L
CROT 8108	80	1080
CROT 8208	80	2080
CROT 8308	80	3080

Dimensions in mm

Dwg. No. 1152

See page 33 line 1150

Specify the required direction of the outlet (ex. CROT 8 108 P)

art. CROT .....



#### THIS LINE IS AVAILABLE WITH ODOR TRAP ON REQUEST

200X200 mm floor drain with odor trap and removable filter basket, overall height 140 mm  
Suitable for slot channels with heelsafe slot

#### Direction of the outlet in the picture: "D" (Right)



See also page 33 line 1250

**N.B.**

- On request, the manhole covers described on pages 14 and 15 can be applied.
- Available with direct outlet (no odor trap, no filter basket).
- Custom made dimensions on request.
- Other diameter sizes and heights on request.
- On request 1/2" inlet socket to let water flush in and clean the drain (art. -IL see page 30).

Dimensions can be modified on request.

These technical drawings are property of INOXSYSTEM® and cannot be copied or reproduced without our prior written permission.

www.inoxsystem.it

made of grade 304 stainless steel - grade 316 on request

### Recessed manhole cover with frame

**heavy duty line**, sheet thickness 3 mm.

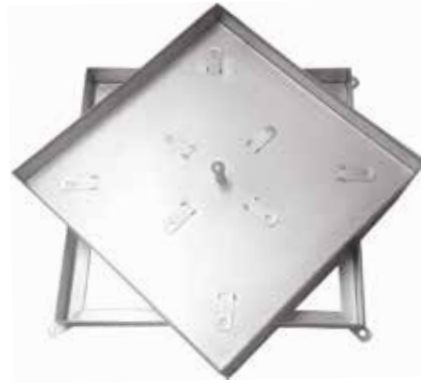
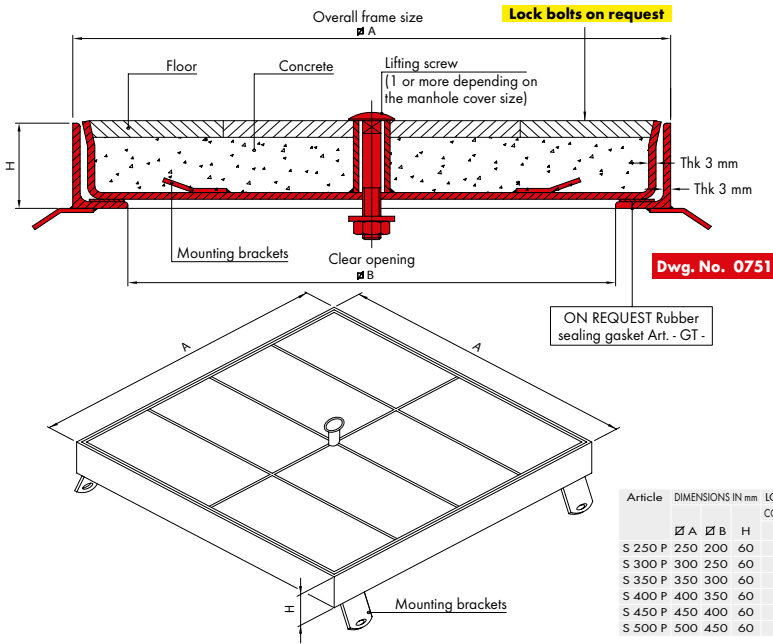

\* = These values depend on the type of concrete. It is possible to install electro-welded galvanized wire mesh (not provided) to reinforce concrete. N.B. - All dimensions can be modified on request.

Article	DIMENSIONS IN mm				LOAD CAPACITY IN Kg*		LOAD CLASS*	Article	DIMENSIONS IN mm				LOAD CAPACITY IN Kg*		LOAD CLASS*
	ø A	ø B	H		CONCENTRATED	DISTRIBUTED			ø A	ø B	H		CONCENTRATED	DISTRIBUTED	
S 250 P	250	200	60		1000	10000	C250	S 550 P	550	500	60	850	6500	B125	
S 300 P	300	250	60		1000	10000	C250	S 600 P	600	550	60	850	6500	B125	
S 350 P	350	300	60		1000	10000	C250	S 650 P	650	600	60	850	6500	B125	
S 400 P	400	350	60		1000	10000	C250	S 700 P	700	650	60	850	6500	B125	
S 450 P	450	400	60		1000	10000	C250	S 750 P	750	700	60	850	6500	B125	
S 500 P	500	450	60		1000	10000	C250	S 800 P	800	750	60	850	6500	B125	

### Recessed manhole cover with frame

**medium duty line**, sheet thickness 1,5 mm.

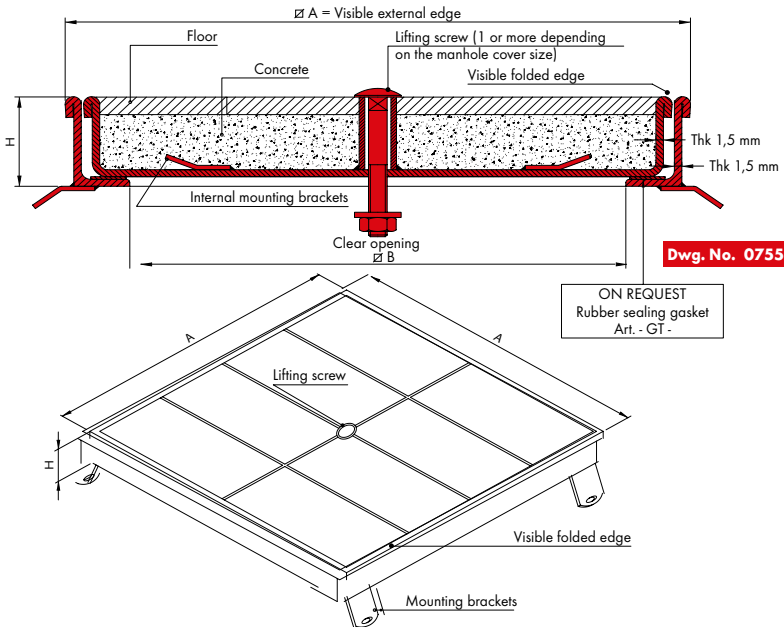

\* = These values depend on the type of concrete. It is possible to install electro-welded galvanized wire mesh (not provided) to reinforce concrete. N.B. - All dimensions can be modified on request.

Article	DIMENSIONS IN mm				LOAD CLASS*	Article	DIMENSIONS IN mm				LOAD CLASS*
	ø A	ø B	H				ø A	ø B	H		
S 250 IP	250	200	60		B125	S 550 IP	550	500	60	A15	
S 300 IP	300	250	60		B125	S 600 IP	600	550	60	A15	
S 350 IP	350	300	60		B125	S 650 IP	650	600	60	A15	
S 400 IP	400	350	60		B125	S 700 IP	700	650	60	A15	
S 450 IP	450	400	60		B125	S 750 IP	750	700	60	A15	
S 500 IP	500	450	60		B125	S 800 IP	800	750	60	A15	

### Pressed steel recessed manhole cover with frame

**light duty line** for pedestrian areas.

### 2 mm thick grating with frame.

Dwg. No. 0753



Article	DIMENSIONS IN mm	LOAD CLASS
SL 230 P	230 x 230 x h50	A15
SL 330 P	330 x 330 x h50	A15
SL 430 P	430 x 430 x h50	A15
SL 530 P	530 x 530 x h50	A15

Clear opening = overall dimensions - 40 mm

Dwg. No. 0754

Article	DIMENSIONS IN mm	LOAD CLASS
SG 160	156 x 156 x h28	*
SG 210	206 x 206 x h28	*
SG 260	256 x 256 x h28	*
SG 310	306 x 306 x h28	*
SG 360	356 x 356 x h28	*
SG 410	406 x 406 x h28	*
SG 460	456 x 456 x h28	*
SG 510	506 x 506 x h28	*

Clear opening = overall dimensions - 35 mm



\* = The load class depends on the type of grating. See page 16 and 35 for other types of gratings.

Dimensions can be modified on request.

These technical drawings are property of INOXSYSTEM® and cannot be copied or reproduced without our prior written permission.



Solid top manhole cover with frame **heavy duty line**

made of grade 304 stainless steel - grade 316 on request  
plate thickness 3-4-6-8 mm **with reinforcing bars.**

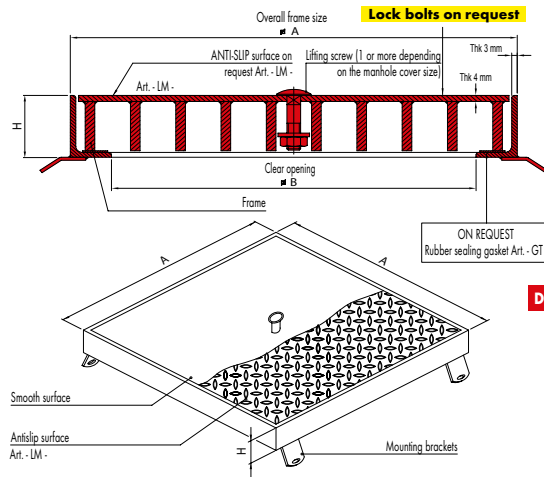

Dwg. No. 0701



\* = These values depend on the type of concrete. It is possible to install electro-welded galvanized wire mesh (not provided) to reinforce concrete.  
N.B. - All dimensions can be modified on request.

Article	DIMENSIONS IN mm			LOAD CAPACITY IN Kg*		LOAD CLASS*	Article	DIMENSIONS IN mm			LOAD CAPACITY IN Kg*		LOAD CLASS*
	Ø A	Ø B	H	CONCENTRATED LOAD	DISTRIBUTED LOAD			CONCENTRATED LOAD	DISTRIBUTED LOAD				
S 250	250	200	35	1000	10000	C250	S 550	550	500	35	850	6500	B125
S 300	300	250	35	1000	10000	C250	S 600	600	550	35	850	6500	B125
S 350	350	300	35	1000	10000	C250	S 650	650	600	35	850	6500	B125
S 400	400	350	35	1000	10000	C250	S 700	700	650	35	850	6500	B125
S 450	450	400	35	1000	10000	C250	S 750	750	700	35	850	6500	B125
S 500	500	450	35	1000	10000	C250	S 800	800	750	35	850	6500	B125

\* Other plate thickness on request

\* Other plate thickness on request

Recessed manhole cover with frame **heavy duty line**

plate thickness 3 mm, floor drain with 8 mm thick top cover incorporated.

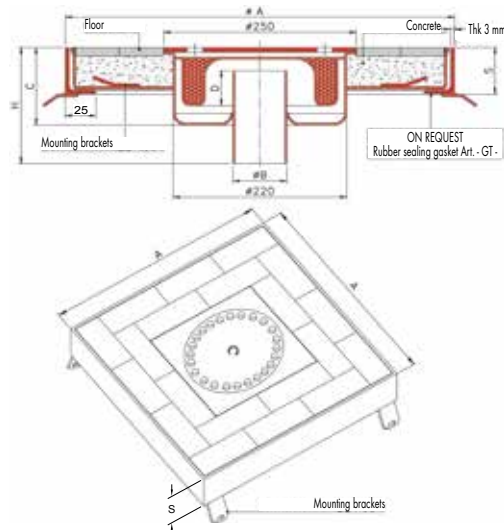

Dwg. No. 0752



**With vertical outlet and removable filter basket**

\* = These values depend on the type of concrete.  
It is possible to install electro-welded galvanized wire mesh (not provided) to reinforce concrete.  
N.B. - All dimensions can be modified on request.

Article	DIMENSIONS IN mm						FLOW RATE lt/min	LOAD CAPACITY IN Kg*		LOAD CLASS*
	Ø A	S	Ø B	C	D	H		CONCENTRATED LOAD	DISTRIBUTED LOAD	
S500P 110 VCE	500	60	110	110	50	180	13.5	850	6500	B125
S600P 110 VCE	600	60	110	110	50	180	13.5	850	6500	B125
S700P 110 VCE	700	60	110	110	50	180	13.5	850	6500	B125
S800P 110 VCE	800	60	110	110	50	180	13.5	850	6500	B125

N.B. gullies with a depth water seal (dimension D) of 50 mm are in compliance with standard UNI EN 1253-1

Solid top manhole cover with frame **heavy duty line**

plate thickness 3-6-8 mm with reinforcing bars, odor trap incorporated.

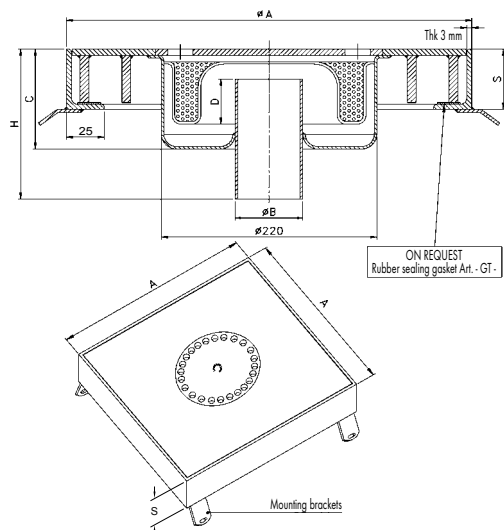

Dwg. No. 0122



**With vertical outlet and removable filter basket**

\* = These values can change depending on sheet thickness and overall dimensions  
N.B. - All dimensions can be modified on request

Article	DIMENSIONS IN mm						FLOW RATE lt/min	LOAD CAPACITY IN Kg*		LOAD CLASS*
	Ø A	S	Ø B	C	D	H		CONCENTRATED LOAD	DISTRIBUTED LOAD	
S400 110 VCE	400	35	110	110	50	180	13.5	850	6500	B125
S500 110 VCE	500	35	110	110	50	180	13.5	850	6500	B125
S600 110 VCE	600	35	110	110	50	180	13.5	850	6500	B125
S700 110 VCE	700	35	110	110	50	180	13.5	850	6500	B125
S800 110 VCE	800	35	110	110	50	180	13.5	850	6500	B125

N.B. gullies with a depth water seal (dimension D) of 50 mm are in compliance with standard UNI EN 1253-1

made of grade 304 stainless steel - grade 316 on request

### Flush mount radiused corner guard for external angles.

**N.B.: Special pieces on request**

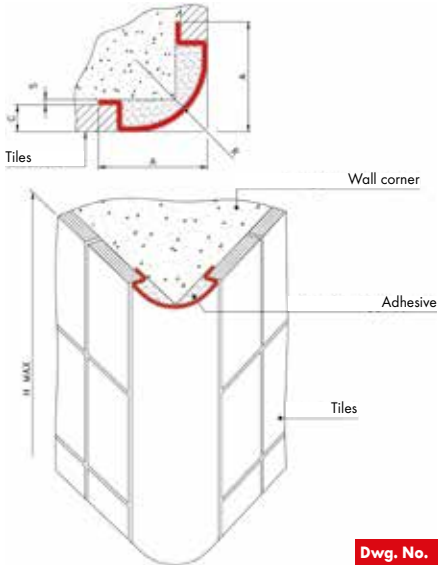

**Dwg. No. 1001**



N.B. - All dimensions can be modified on request  
CIRCLE POLISHED SURFACE FINISH  
On request satin finish or other finishes

Article	DIMENSIONS IN mm					CIRCLE POLISHED SURFACE FINISH
	A	H	C	S	R	
PR 50 1	50	3000	8	1	12,5	CIRCLE POLISHED SURFACE FINISH
PR 70 1	70	3000	8	1	25	CIRCLE POLISHED SURFACE FINISH

### Flush mount corner guard for external angles.

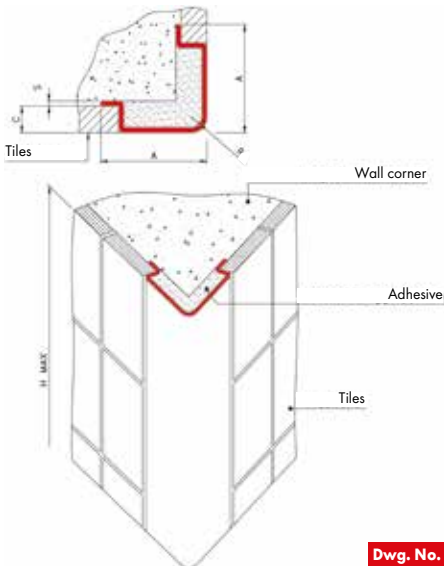

**Dwg. No. 1002**



N.B. - All dimensions can be modified on request  
CIRCLE POLISHED SURFACE FINISH  
On request satin finish or other finishes

Article	DIMENSIONS IN mm					CIRCLE POLISHED SURFACE FINISH
	A	H	C	S	R	
P 50 1	50	3000	8	1	4	CIRCLE POLISHED SURFACE FINISH
P 70 1	70	3000	8	1	4	CIRCLE POLISHED SURFACE FINISH

### Flush mount radiused corner guard for internal angles.

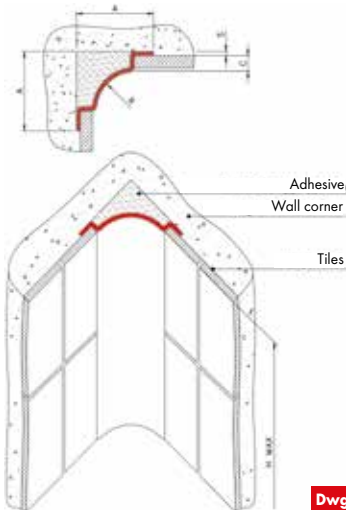

**Dwg. No. 1005**



N.B. - All dimensions can be modified on request  
STANDARD SURFACE FINISH: circle-polished  
On request satin finish or other finishes

Article	DIMENSIONS IN mm					CIRCLE POLISHED SURFACE FINISH
	A	H	C	S	R	
PRA 50 1	50	3000	8	1	12,5	CIRCLE POLISHED SURFACE FINISH
PRA 70 1	70	3000	8	1	25	CIRCLE POLISHED SURFACE FINISH

Dimensions can be modified on request.

These technical drawings are property of INOXSYSTEM® and cannot be copied or reproduced without our prior written permission.



made of grade 304 stainless steel - grade 316 on request

### Surface mount corner guard for external and internal angles. **N.B.: Special pieces on request**

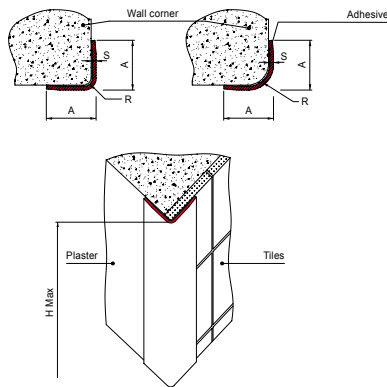

N. B. - All dimensions can be modified on request  
STANDARD SURFACE FINISH: circle-polished  
On request satin finish or other finishes

Article	DIMENSIONS IN mm				Surface finish
	A	H	S	R	
P 30 30 1	30	3000	1	4	Circle polished
PR 30 30 1	30	3000	1	12,5	Circle polished
P 50 50 1	50	3000	1	4	Circle polished
PR 50 50 1	50	3000	1	12,5	Circle polished

Dwg. No. 1003

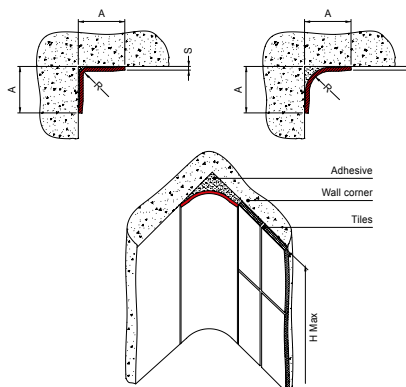

N. B. - All dimensions can be modified on request  
STANDARD SURFACE FINISH: circle-polished  
On request satin finish or other finishes

Article	DIMENSIONS IN mm				Surface finish
	A	H	S	R*	
PA 30 30 1	30	3000	1	4	Circle polished
PRA 30 30 1	30	3000	1	12,5	Circle polished
PA 50 50 1	50	3000	1	4	Circle polished
PRA 50 50 1	50	3000	1	12,5	Circle polished

Dwg. No. 1006

### Floor profile.

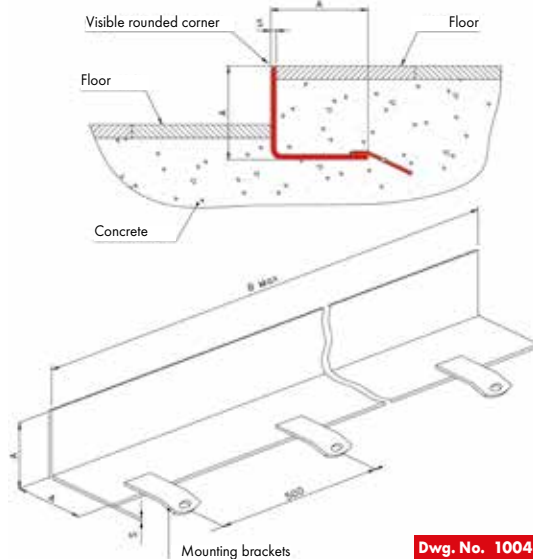

Dwg. No. 1004

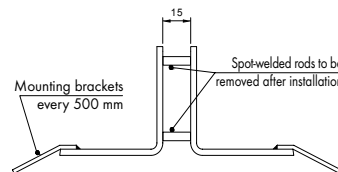

Dwg. No. 1014

On request  
floor movement  
joints

Article  
T 70 4 D

Different slot widths on request



Article  
T 70 4

N.B. - All dimensions can be modified on request

Article	DIMENSIONS IN mm		
	A	B	S
T 70 4	70	3000	4
T 70 4 D	70	3000	4

### Examples of installation of corner guards and floor profiles.



Radiused corner guard - Dwg. No. 1001



Dwg. No. 1004



Dwg. No. 1004

Dimensions can be modified on request.

These technical drawings are property of INOXSYSTEM® and cannot be copied or reproduced without our prior written permission.

made of grade 304 stainless steel - grade 316 on request

Floor drain with odor trap and filter basket, with round flange for waterproof membrane application.

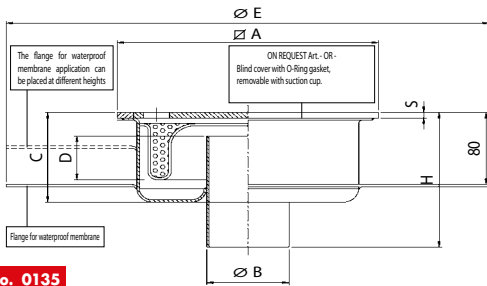

Dwg. No. 0135

N.B. - Some dimensions can be made custom

Article	DIMENSIONS IN mm							FLOW RATE lt/min	LOAD CAPACITY IN Kg	
	Ø A	S	Ø B	C	D	H	Ø E		CONCENTRATED LOAD	DISTRIBUTED LOAD
SG 110 VCE 308	300	8	110	110	55	180	400	135	1000	10000

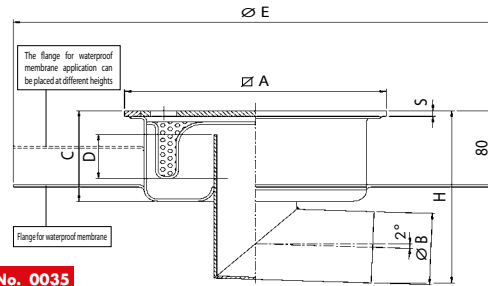

Dwg. No. 0035

N.B. - Some dimensions can be made custom

Article	DIMENSIONS IN mm							FLOW RATE lt/min	LOAD CAPACITY IN Kg	
	Ø A	S	Ø B	C	D	H	Ø E		CONCENTRATED LOAD	DISTRIBUTED LOAD
SG 110 LCE 308	300	8	110	110	55	220	400	135	1000	10000

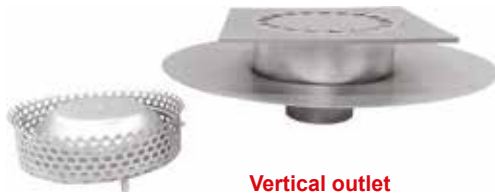

Vertical outlet

The flange for waterproof membrane application can be installed also on the floor drains at page 8 and 9



Horizontal outlet

Telescopic floor drain with odor trap and filter basket, with round flange for waterproof membrane application.

Telescopic solution enables height adjustment of the gully and fast installation on site.  
The round flange is ideal for application of waterproof membrane.

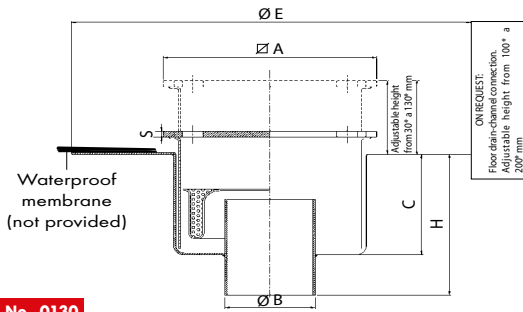

Dwg. No. 0130

N.B. - Some dimensions can be made custom

Article	DIMENSIONS IN mm						FLOW RATE lt/min	LOAD CAPACITY IN Kg	
	Ø A	S	Ø B	C	H	Ø E		CONCENTRATED LOAD	DISTRIBUTED LOAD
CT 110 VCE 308	300	8	110	140	210	500	135	1000	10000

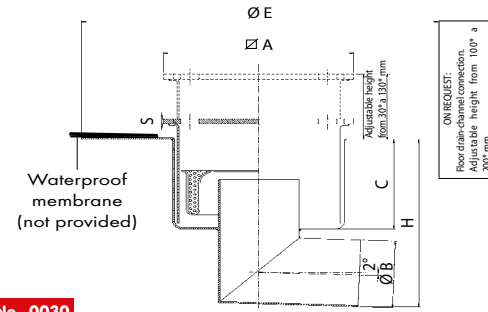

Dwg. No. 0030

N.B. - Some dimensions can be made custom

Article	DIMENSIONS IN mm						FLOW RATE lt/min	LOAD CAPACITY IN Kg	
	Ø A	S	Ø B	C	H	Ø E		CONCENTRATED LOAD	DISTRIBUTED LOAD
CT 110 LCE 308	300	8	110	140	250	500	135	1000	10000



Vertical outlet



Horizontal outlet

Inoxsystem® type stainless steel pipe union ("Mexican" pipe union).

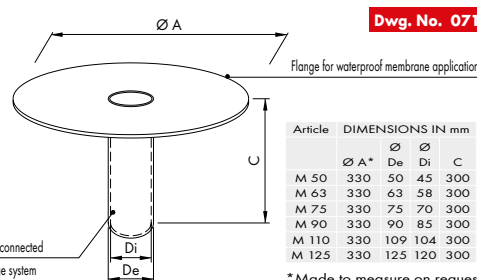
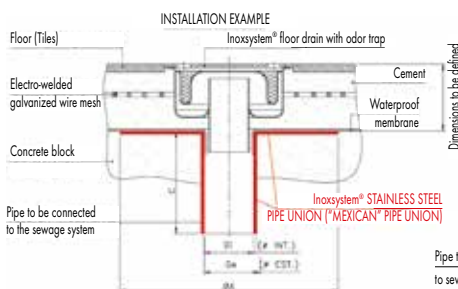

Dwg. No. 0710

Article	DIMENSIONS IN mm				Maximum Ø size of floor drains outlet
	Ø A*	Ø D1	Ø D2	C	
M 50	330	50	45	300	Suitable for Ø 40
M 63	330	63	58	300	Suitable for Ø 50
M 75	330	75	70	300	Suitable for Ø 63
M 90	330	90	85	300	Suitable for Ø 80
M 110	330	109	104	300	Suitable for Ø 90
M 125	330	125	120	300	Suitable for Ø 110

\* Made to measure on request



Dimensions can be modified on request.

These technical drawings are property of INOXSYSTEM® and cannot be copied or reproduced without our prior written permission.



made of grade 304 stainless steel - grade 316 on request

## Flange for waterproof membrane application.

### Dwg. 0935: CHANNEL WITH GRATING

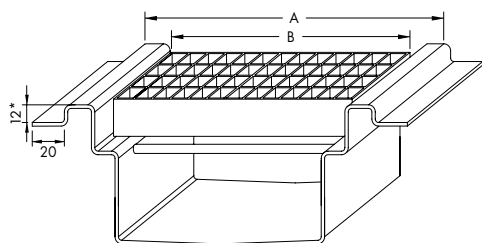

Dwg. No. 0935

Article	CGS 0935
---------	----------

11 \*If turnout dimension is 15 mm the grating height will be 30 mm  
Flange suitable for channels at page 16

### Dwg. 5025: Inoxsystem® Total Hygienic CHANNEL

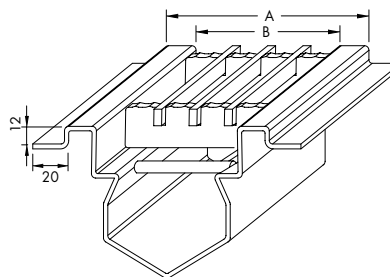

Dwg. No. 5025

Article	A	B
TH 100 BPG	100	67

12 \*For more information see page 49

### Dwg. 2025: SLOT CHANNEL

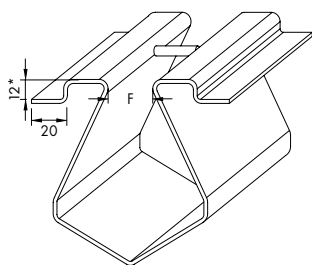

Dwg. No. 2025

Article	F
C1 2025	8 mm slot
C2 2025	20 mm slot

13 \*Turndown dimension should be 15 mm on request  
Flange suitable for channels at page 12

### Dwg. 2011: HIDDEN SLOT CHANNEL

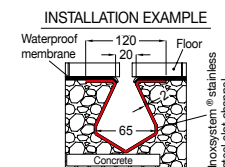
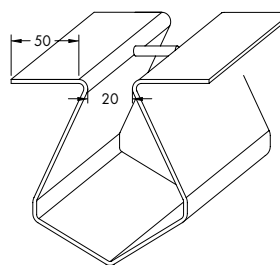

Dwg. No. 2011

Article	C2 BDL
---------	--------

6 To be installed under the floor. With straight horizontal edges  
See page 35 lines 0450 and 0460

## Inoxsystem® ITALIA IDrain LINEAR SHOWER DRAINS

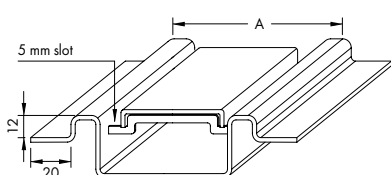

17

Dwg. No. 3025

Article	A
ID85 BPG	85
ID115 BPG	115

\*Turndown dimension should be 15 mm on request.  
Flange suitable for Inoxsystem® Italia IDrain linear shower drains. Recommended for channels with regular depth.

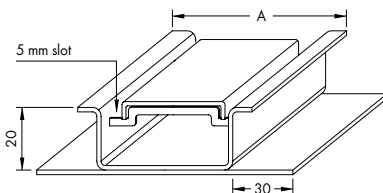

37

Dwg. No. 3028

Article	A
ID70 + IDP110	70
ID100 + IDP140	100

Flange suitable for Inoxsystem® Italia IDrain linear shower drains. Recommended for channels with regular depth.

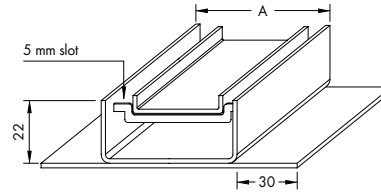

38

Dwg. No. 3029

Article	A
ID54P + IDP110	54
ID84P + IDP140	84

Flange suitable for Inoxsystem® Italia IDrain linear shower drains. Recommended for channels with regular depth.

## INSTALLATION EXAMPLES



- 11 channel with grating with flange for waterproof membrane application
- 12 Inoxsystem® Total Hygienic channel with with flange for waterproof membrane application
- 13 slot channel with flange for waterproof membrane application
- 6 hidden slot channel with flange for waterproof membrane application
- 17 Inoxsystem® Italia IDrain linear shower drain with satin finished cover and flange for waterproof membrane application
- 37 Inoxsystem® Italia IDrain linear shower drain with tileable cover and with flange for waterproof membrane application

made of grade 304 stainless steel - grade 316 on request

Folded edges with flange waterproof membrane application.

### Dwg. 0926: CHANNEL WITH GRATING

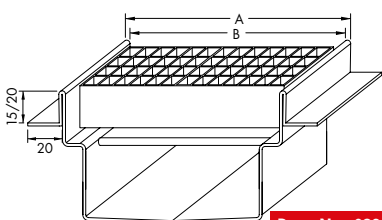

Dwg. No. 0926

21	Article	A (Overall dim.)
	CGS 0926	Variable

Folded edges with flange suitable for channels at page 16

### Dwg. 2026: CENTRAL SLOT WITH VERTICAL EDGES

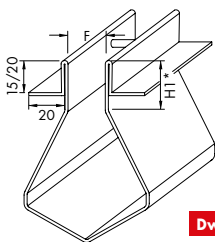

Dwg. No. 2026

\*Dimension H1 = 30 mm minimum

24	Article	F (Slot)
	C1BDV 2026	8 mm slot
	C2BDV 2026	20 mm slot

Folded edges with flange suitable for channels at page 13

### Dwg. 2015: CENTRAL SLOT WITH VERTICAL EDGES-FLAT UPPER SURFACE

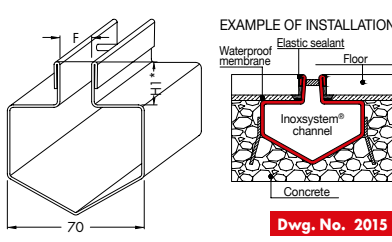

Dwg. No. 2015

\*Dimension H1 = 15 mm minimum

MINIMUM STARTING DEPTH = H1 + 40 mm

14	Article	F (Slot)
	C1BDV PM	8 mm slot
	C2BDV PM	20 mm slot

### Dwg. 5026: Inoxsystem® Total Hygienic CHANNEL

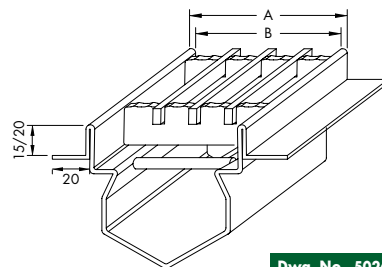

Dwg. No. 5026

22	Article	A	B
	TH 80 BPGPS	78	67

\*For more information see page 49

### Dwg. 2027: LATERAL SLOT WITH VERTICAL EDGES

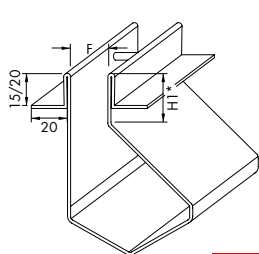

Dwg. No. 2027

\*Dimension H1 = 30 mm minimum

25	Article	F (Slot)
	C1BDVL 2027	8 mm slot
	C2BDVL 2027	20 mm slot

Folded edges with flange suitable for channels at page 13

### Dwg. 2016: OFFSET SLOT WITH VERTICAL EDGES-FLAT UPPER SURFACE

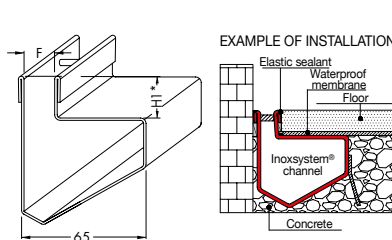

Dwg. No. 2016

\*Dimension H1 = 15 mm minimum

MINIMUM STARTING DEPTH = H1 + 30 mm

15	Article	F (Slot)
	C1BDVL PM	8 mm slot
	C2BDVL PM	20 mm slot

## Inoxsystem® Italia IDrain LINEAR SHOWER DRAINS

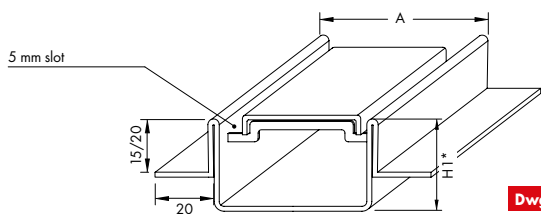

Dwg. No. 3026

\*Dimension H1 = 35 mm minimum

27a	Article	A (Overall dim.)	H1 max
	ID60 BPGPS	60	45 mm
	ID90 BPGPS	90	75 mm

Folded edges with flange suitable for Inoxsystem® Italia IDrain linear shower drains

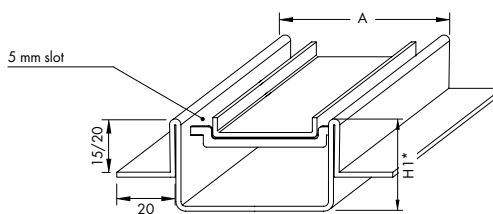

Dwg. No. 3027

\*Dimension H1 = 35 mm minimum

27b	Article	A (Esterno)	A (Overall dim.)
	ID60P BPGPS	60	45 mm
	ID90P BPGPS	90	75 mm

\*With tileable cover

Folded edges with flange suitable for Inoxsystem® Italia IDrain channels

## INSTALLATION EXAMPLES



- 21 Channel with grating with folded edges and flange for connection of waterproof membrane
- 22 Inoxsystem® Total Hygienic channel with grating with folded edges and flange for connection of waterproof membrane
- 23 Channel with central slot and folded edges with flange for connection of waterproof membrane
- 24 Slot channel with lateral slot and folded edges with flange for connection of waterproof membrane
- 14 Slot channel with central slot and vertical edges, with flat upper surface for waterproof membrane application
- 15 Slot channel with lateral slot and vertical edges, with flat upper surface for waterproof membrane application
- 27a Inoxsystem® Italia IDrain linear shower drain with satin finished cover and folded edges with flange for connection of waterproof membrane
- 27b Inoxsystem® Italia IDrain linear shower drain with tileable cover and folded edges with flange for connection of waterproof membrane



made of grade 304 stainless steel - grade 316 on request

### Floor drains with clamping flange for PVC flooring.

Dwg. No. 0113TPVC

Dwg. No. 0010TPVC

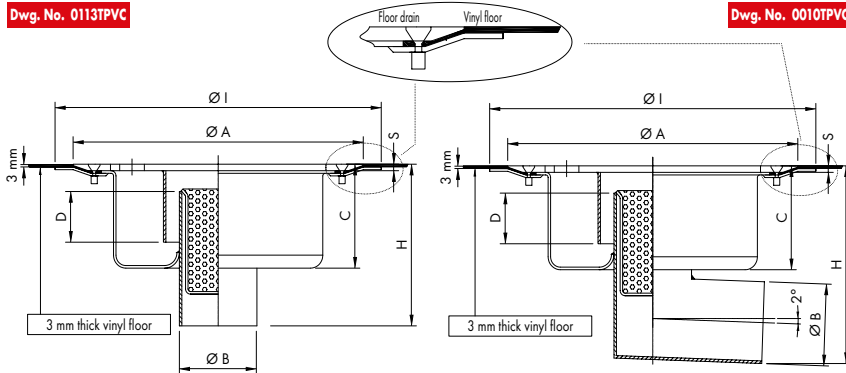

Article	DIMENSIONS IN mm							FLOW RATE	LOAD CAPACITY IN Kg	
	Ø A	S	Ø B	C	I	D	H		CONCENTRATED LOAD	DISTRIBUTED LOAD
R=low profile										
R50V206TPVC	225	6	50	50	265	20	90	50	1000	10000
63V206TPVC	225	6	63	75	265	40	120	60	1000	10000

Article	DIMENSIONS IN mm							FLOW RATE	LOAD CAPACITY IN Kg	
	Ø A	S	Ø B	C	I	D	H		CONCENTRATED LOAD	DISTRIBUTED LOAD
R=low profile										
R50L206TPVC	225	6	50	50	265	20	105	50	1000	10000
63L206TPVC	225	6	63	75	265	40	140	60	1000	10000

### Gullies and channels with grating with clamping flange for PVC flooring\*

\* suitable for all articles at page 18 and 19.

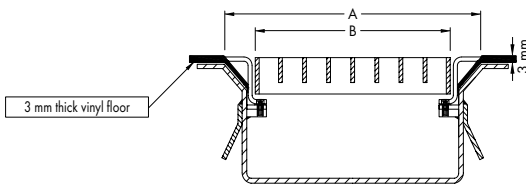

Gully with grating

Channel with grating

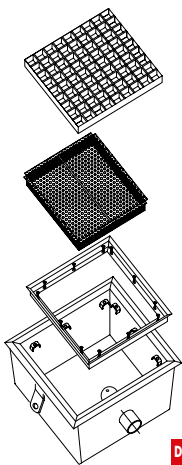

Dwg. No. 0412TPVC

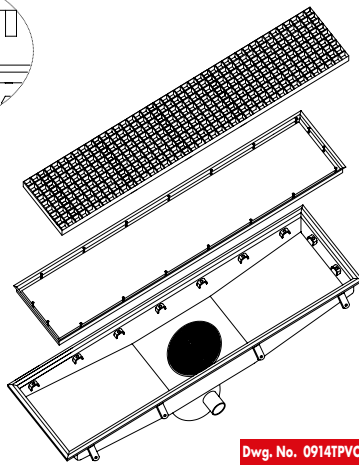

Dwg. No. 0914TPVC



### Linear shower drains Italia with clamping flange for PVC flooring\*

\* suitable for line 3050 at page 38 and line 3150 at page 39.

Dwg. No. 3050TPVC

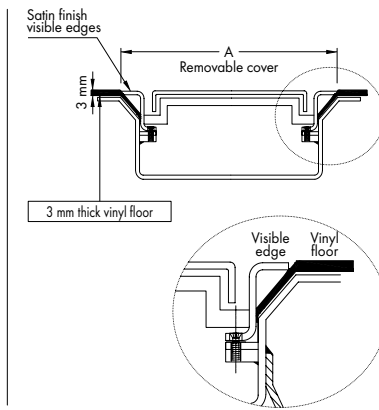
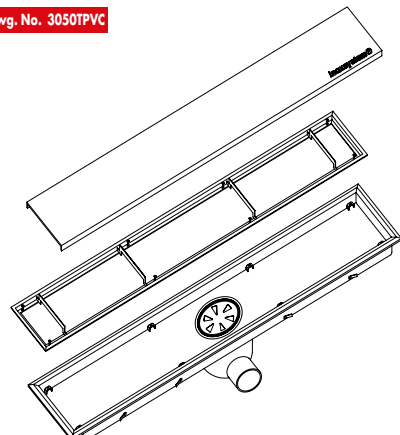

Dimensions can be modified on request.

These technical drawings are property of INOXSYSTEM® and cannot be copied or reproduced without our prior written permission.

made of grade 304 stainless steel - grade 316 on request

### Radius slot channel.

- Art. C1R: Radius slot channel with 8 mm heelsafe slot
- Art. C2R: Radius slot channel with 20 mm standard slot
- Art. C1BDVR: Radius slot channel with 8 mm heelsafe slot and vertical edges
- Art. C2BDVR: Radius slot channel with 20 mm standard slot and vertical edges
- Art. C1BDVLR: Radius slot channel with 8 mm heelsafe lateral slot and vertical edges
- Art. C2BDVLR: Radius slot channel with 20 mm standard lateral slot and vertical edges

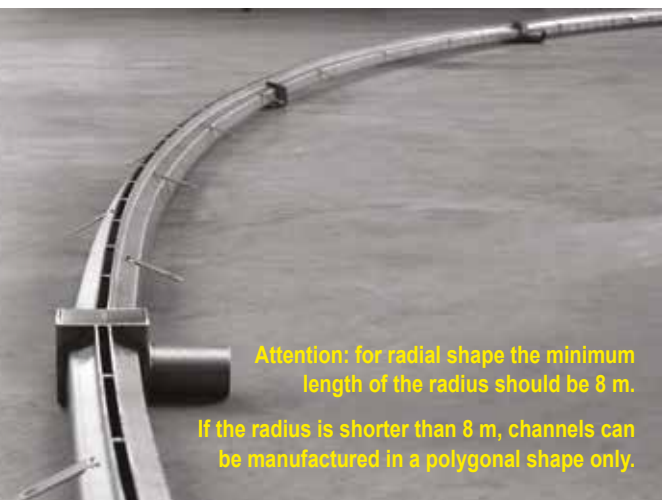

Attention: for radial shape the minimum length of the radius should be 8 m.

If the radius is shorter than 8 m, channels can be manufactured in a polygonal shape only.

### Corner unit with square top plate, with one floor drain-channel connection.

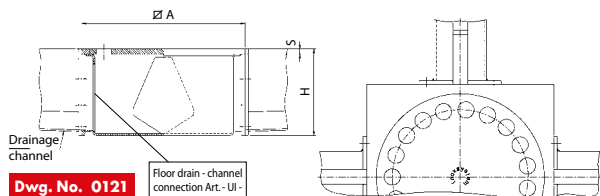

Article	DIMENSIONS IN mm			LOAD CAPACITY IN Kg	
	Ø A	S	H	CONCENTRATED LOAD	DISTRIBUTED LOAD
** CC 80	80	3	*	1000	10000
** CC 100	100	3	*	900	8000
CC 156	150	6	*	1000	10000
CC 206	200	6	*	1000	10000
CC 258	250	8	*	1000	10000
CC 308	300	8	*	1000	10000

\* = Variable dimensions depending on the channel height  
 \*\* = Article CC80 and CC100 are provided with blind cover



### Accessories available on request.

Art. IL: 1/2" inlet socket to let water flush in and clean the drain

Art. BCR: Reinforced edges filled with epoxy resin - Load class D400  
See page 3

Art. PL: Adjustable levelling feet  
 Art. A90: Slot channel angle  
 Art. A90G: Channel with grating angle

Art. UI: Floor-drain channel connection for slot channels  
 Art. UIG: Floor-drain channel connection for channels with grating  
 Art. FLC: Connection flanges for transport and installation of slot channels  
 Art. FLG: Connection flanges for transport and installation of channel with grating



### Different types of top inner covers available on request\*

\* always check if it is possible to replace the standard cover with these special covers



Recommended: INOXYSTEM® anticut Standard cover



Blind cover with O-ring gasket



Multi-slot cover



Customized cover



Cowslip cover



Daisy cover



Sunflower cover



Tulip cover

On request fixing screw Art. VF

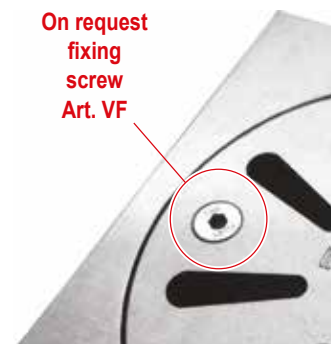



### Front view with central floor drain.

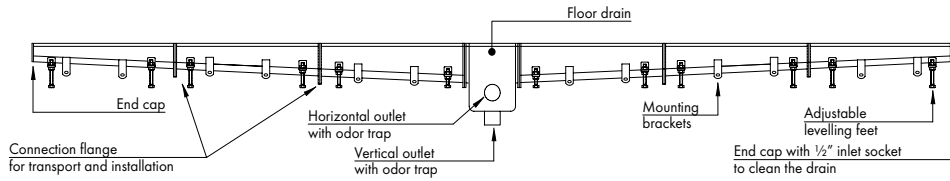

### Front view with floor drain at one end.

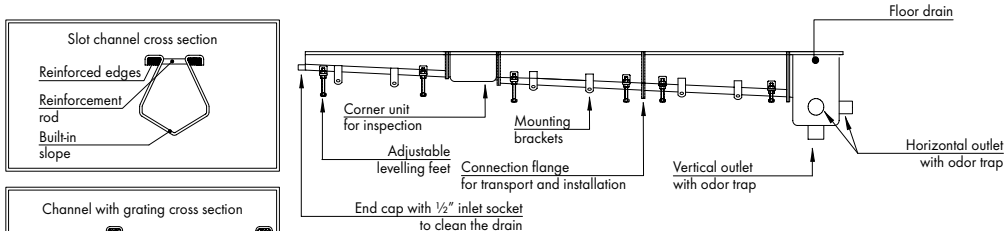

### Front view with off-set floor drain.

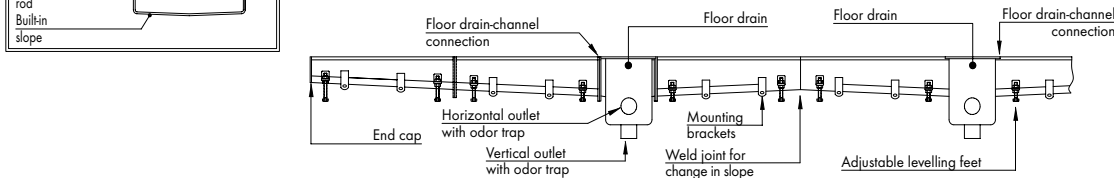

### Front view with direct outlet.

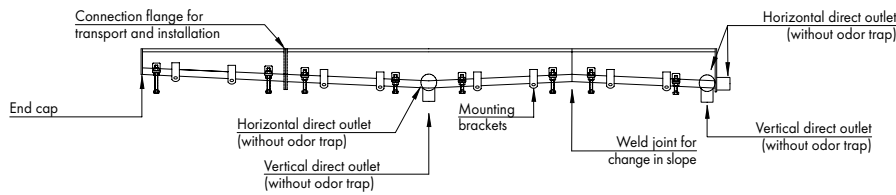

### General top view.

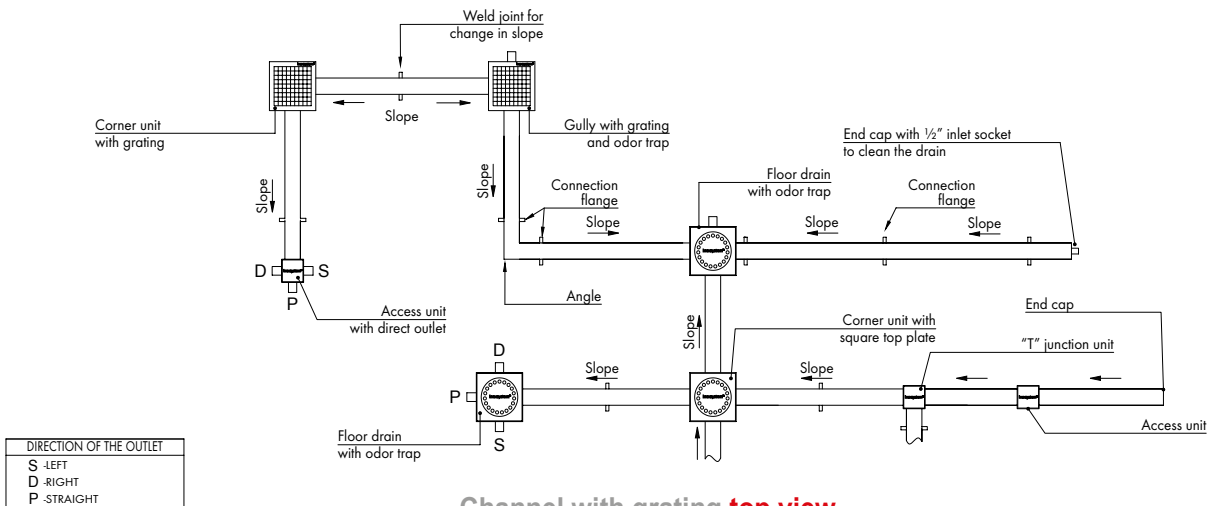

### Channel with grating top view.

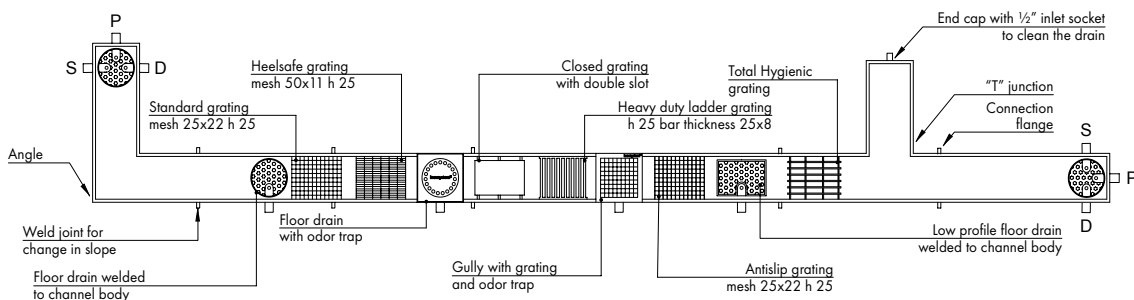

Dimensions can be modified on request.

These technical drawings are property of INOXSYSTEM® and cannot be copied or reproduced without our prior written permission.

made of grade 304 stainless steel - grade 316 on request  
Inoxsystem® modular lines made to measure on request with connection flanges, reinforced edges, etc.

**Line 1050**

- 20 mm standard slot
- With low profile floor drain
- 300x300 mm top cover outlet  $\varnothing$  63 mm, h 140 mm
- With odor trap and filter basket
- See pages 8 and 9 for more details

SLOT CHANNEL CROSS SECTION  
Art. Inoxsystem® -C2-

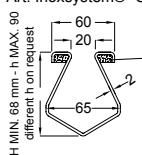

ON REQUEST:  
reinforced  
edges filled  
with epoxy resin  
Art. - BCR -



RECOMMENDED FOR PROFESSIONAL KITCHENS AND FOOD PROCESSING FACILITIES

CENTRAL VERTICAL OUTLET

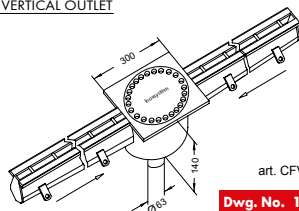

art. CFV .....  
Dwg. No. 1053

CENTRAL HORIZONTAL OUTLET

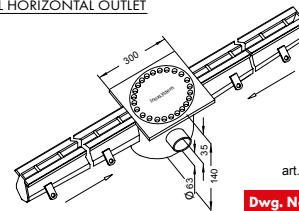

art. CFO .....  
Dwg. No. 1051

END VERTICAL OUTLET

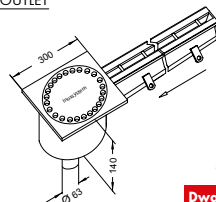

art. CFVT .....  
Dwg. No. 1054

END HORIZONTAL OUTLET

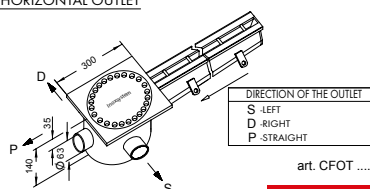

art. CFOT .....  
Dwg. No. 1052

**Line 1060**

- 20 mm standard slot
- With standard floor drain
- 300x300 mm top cover outlet  $\varnothing$  110 mm, h 220 mm
- With odor trap and filter basket
- See pages 8 and 9 for more details

SLOT CHANNEL CROSS SECTION  
Art. Inoxsystem® -C2-

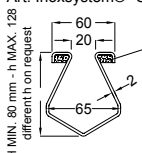

ON REQUEST:  
reinforced  
edges filled  
with epoxy resin  
Art. - BCR -



RECOMMENDED FOR FOOD PROCESSING FACILITIES, CIVIL AND INDUSTRIAL USE

CENTRAL VERTICAL OUTLET

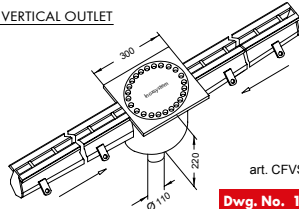

art. CFVS .....  
Dwg. No. 1063

CENTRAL HORIZONTAL OUTLET

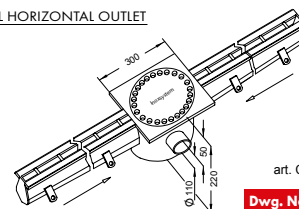

art. CFOS .....  
Dwg. No. 1061

END VERTICAL OUTLET

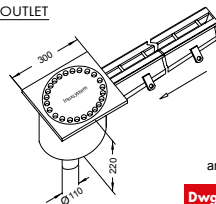

art. CFVTS .....  
Dwg. No. 1064

END HORIZONTAL OUTLET

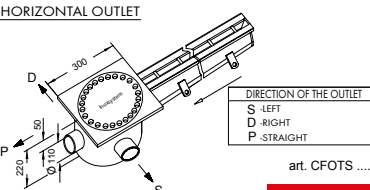

art. CFOTS .....  
Dwg. No. 1062

**Line 2250**

- 20 mm standard slot
- With gully with grating
- 300x300 mm gully outlet  $\varnothing$  110 mm, h 220 mm
- With odor trap and filter basket
- See pages 8 and 9 for more details

SLOT CHANNEL CROSS SECTION  
Art. Inoxsystem® -C2-

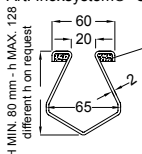

ON REQUEST:  
reinforced  
edges filled  
with epoxy resin  
Art. - BCR -



IDEAL FOR PROFESSIONAL KITCHENS AND FOOD PROCESSING FACILITIES

CENTRAL VERTICAL OUTLET

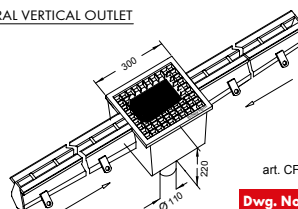

art. CFVCG .....  
Dwg. No. 2253

CENTRAL HORIZONTAL OUTLET

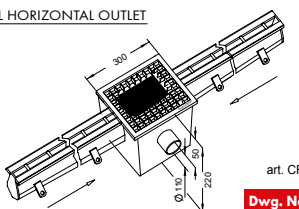

art. CFOCG .....  
Dwg. No. 2251

END VERTICAL OUTLET

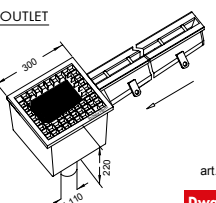

art. CFVTCG .....  
Dwg. No. 2254

END HORIZONTAL OUTLET

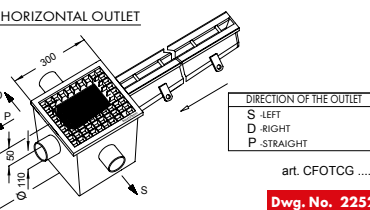

art. CFOTCG .....  
Dwg. No. 2252

**Line 1070**

- 20 mm standard slot
- Extra wide version
- 350x350 mm top cover outlet  $\varnothing$  160 mm, h 250/300 mm
- With odor trap and filter basket
- See pages 8 and 9 for more details

SLOT CHANNEL CROSS SECTION  
Art. Inoxsystem® -MC2-

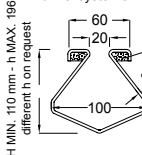

ON REQUEST:  
reinforced  
edges filled  
with epoxy resin  
Art. - BCR -



DEVELOPED FOR THE DRAINAGE OF LARGE VOLUMES OF WATER

CENTRAL VERTICAL OUTLET

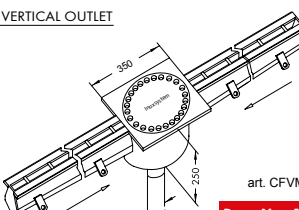

art. CFVM .....  
Dwg. No. 1073

CENTRAL HORIZONTAL OUTLET

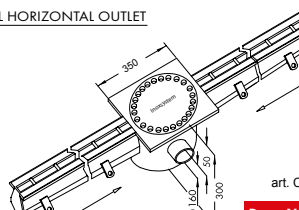

art. CFOM .....  
Dwg. No. 1071

END VERTICAL OUTLET

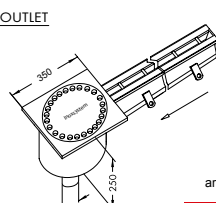

art. CFVTM .....  
Dwg. No. 1074

END HORIZONTAL OUTLET

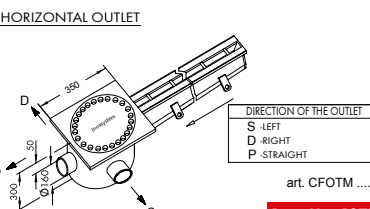

art. CFOTM .....  
Dwg. No. 1072

MADE TO MEASURE

www.inoxsystem.it



made of grade 304 stainless steel - grade 316 on request  
Inoxsystem® modular lines made to measure on request with connection flanges, reinforced edges, etc.

**Line 1250**

- 8 mm Heelsafe slot
- Version with odor trap
- 200x200 mm top cover
- outlet Ø 63 mm, h 140 mm
- With odor trap and filter basket
- See pages 8 and 9 for more details

SLOT CHANNEL CROSS SECTION  
Art. Inoxsystem® -C1-

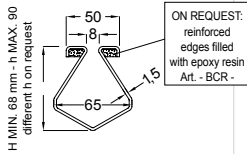

IDEAL FOR SWIMMING POOLS, TERRACES, SHOWERS, GYMS, PUBLIC AREAS

CENTRAL VERTICAL OUTLET

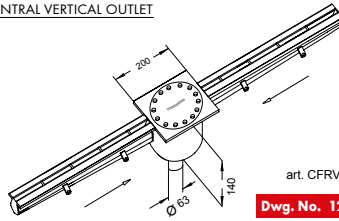

CENTRAL HORIZONTAL OUTLET

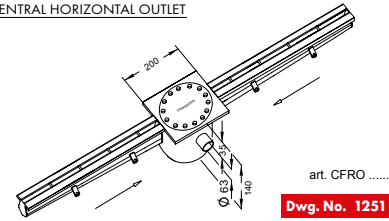

END VERTICAL OUTLET

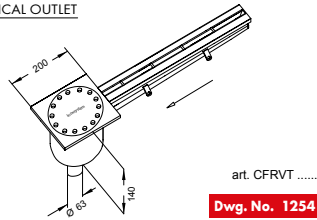

END HORIZONTAL OUTLET

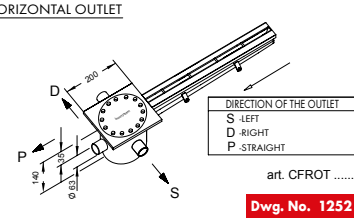

**Line 1150**

- 8 mm Heelsafe slot
- Version without odor trap, with access unit
- 80x80 mm access unit with outlet Ø 63 mm, h 100 mm
- Direct outlet with filter basket
- See pages 8 and 9 for more details

SLOT CHANNEL CROSS SECTION  
Art. Inoxsystem® -C1-

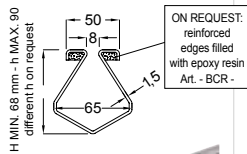

RECOMMENDED FOR SWIMMING POOLS, TERRACES, SHOWERS, GYMS, PUBLIC AREAS

CENTRAL VERTICAL OUTLET

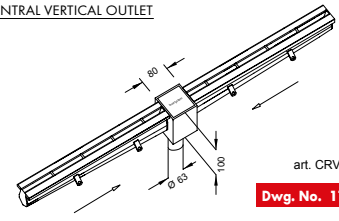

CENTRAL HORIZONTAL OUTLET

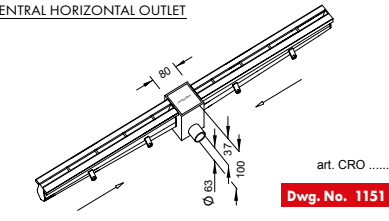

END VERTICAL OUTLET

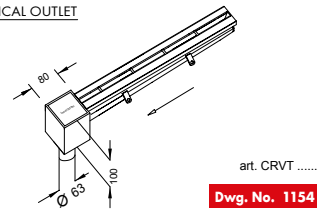

END HORIZONTAL OUTLET

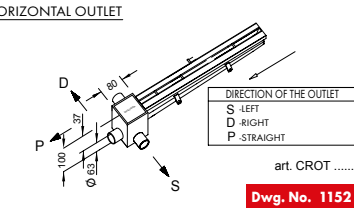

**Line 1350**

- 8 mm Heelsafe slot
- Version without odor trap, without access unit
- Direct outlet Ø 63 mm, h 100 mm
- Direct outlet without filter basket
- See pages 12, 14 and 15 for more details

SLOT CHANNEL CROSS SECTION  
Art. Inoxsystem® -C1-

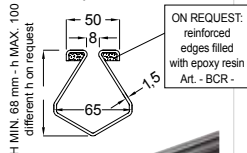

IDEAL FOR SWIMMING POOLS, TERRACES, SHOWERS, GYMS, PUBLIC AREAS

CENTRAL VERTICAL OUTLET

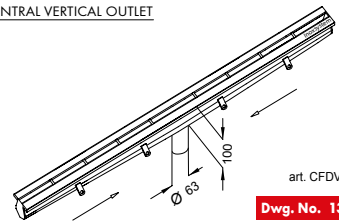

CENTRAL HORIZONTAL OUTLET

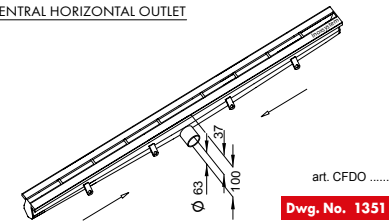

END VERTICAL OUTLET

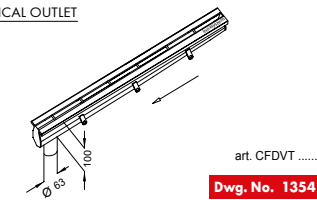

END HORIZONTAL OUTLET

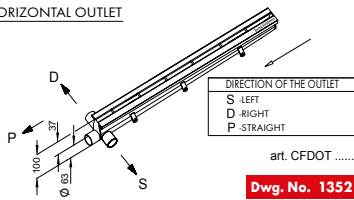

**Choose the slot width that best suits your needs**

**STANDARD SLOT**



- Ideal for:**
- Professional kitchens
  - Wineries
  - Slaughter houses
  - Fish shops
  - Cheese factories
  - Food processing facilities
  - Etc.

**HEELSAFE SLOT**



- Ideal for:**
- Showers
  - Sports facilities
  - Terraces
  - Parkings
  - Squares
  - Swimming pools
  - shopping centres
  - Etc.

EACH LINE SHOULD BE MANUFACTURED WITH STANDARD OR HEELSAFE SLOT

LETTER "R" MEANS 8 mm HEELSAFE SLOT, LETTER "S" MEANS 20 mm STANDARD SLOT

EXAMPLE:  
LINE 1050, ARTICLE "CFV"  
IF WITH HEELSAFE SLOT, THE ARTICLE WILL BE CFVR;  
IF WITH STANDARD SLOT, THE ARTICLE WILL BE CFVS;

made of grade 304 stainless steel - grade 316 on request  
Inoxsystem® modular lines made to measure on request with connection flanges, reinforced edges, etc.

### Line 0910

- Channel with grating
- Version with odor trap
- Floor drain outlet Ø 63 mm, h 130 - 170 mm
- With odor trap and filter basket
- See pages 16 and 17 for more details

#### CHANNEL CROSS SECTION

Art. Inoxsystem® -CGS...

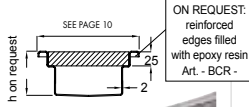

RECOMMENDED FOR PROFESSIONAL KITCHENS AND FOOD PROCESSING FACILITIES

#### CENTRAL VERTICAL OUTLET

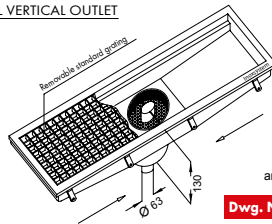

#### CENTRAL HORIZONTAL OUTLET

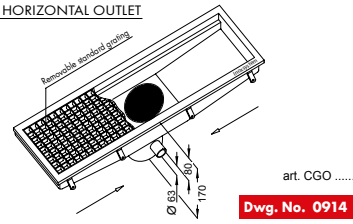

#### END VERTICAL OUTLET

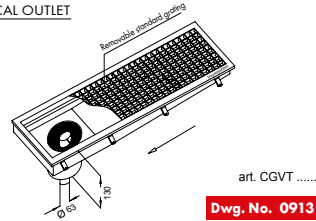

#### END HORIZONTAL OUTLET

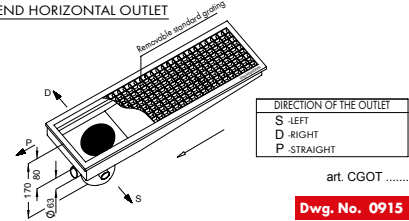

### Line 0920

- Channel with grating
- Version with low profile floor drain with odor trap
- Outlet Ø 63 mm, h to be defined
- With odor trap and filter basket
- See pages 16 and 17 for more details

#### CHANNEL CROSS SECTION

Art. Inoxsystem® -CGS...

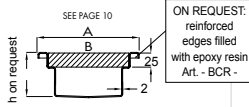

RECOMMENDED FOR PROFESSIONAL KITCHENS AND FOOD PROCESSING FACILITIES

#### CENTRAL VERTICAL OUTLET

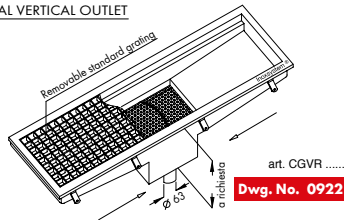

#### CENTRAL HORIZONTAL OUTLET

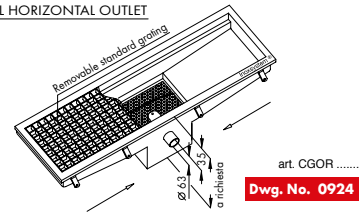

#### END VERTICAL OUTLET

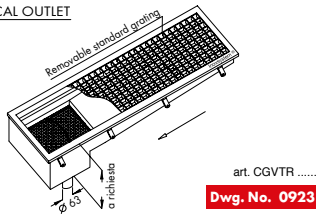

#### END HORIZONTAL OUTLET

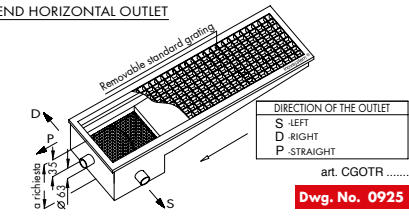

### Line 2050

- Channel with grating
- Version with floor drain with square top plate and odor trap
- 300x300 mm top plate, Ø 110 mm, h 220 mm
- With odor trap and filter basket
- See pages 16 and 17 for more details

#### CHANNEL CROSS SECTION

Art. Inoxsystem® -CGS...

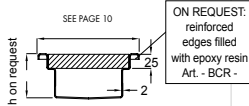

RECOMMENDED FOR FOOD PROCESSING FACILITIES, CIVIL AND INDUSTRIAL USE

#### CENTRAL VERTICAL OUTLET

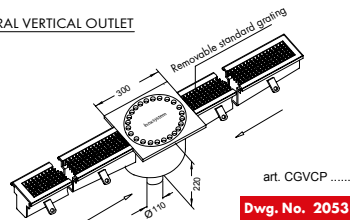

#### CENTRAL HORIZONTAL OUTLET

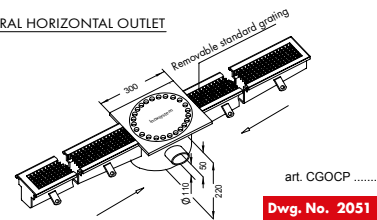

#### END VERTICAL OUTLET

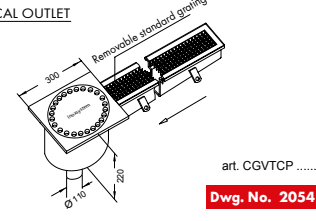

#### END HORIZONTAL OUTLET

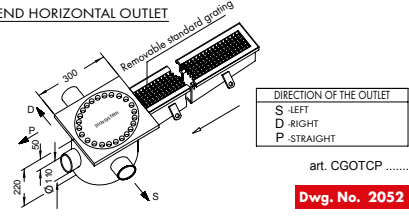

### Line 2150

- Channel with grating
- Version with gully with grating and odor trap
- 300x300 mm gully, Ø 110 mm, h 220 mm
- With odor trap and filter basket
- See pages 16 and 17 for more details

#### CHANNEL CROSS SECTION

Art. Inoxsystem® -CGS...

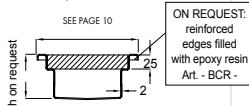

RECOMMENDED FOR FOOD PROCESSING FACILITIES, CIVIL AND INDUSTRIAL USE

#### CENTRAL VERTICAL OUTLET

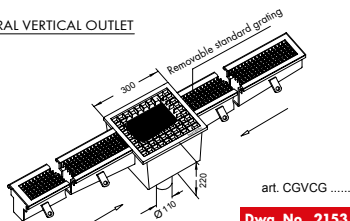

#### CENTRAL HORIZONTAL OUTLET

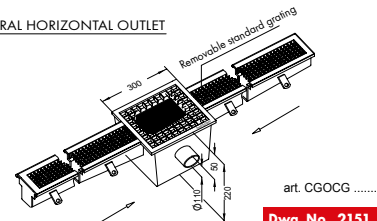

#### END VERTICAL OUTLET

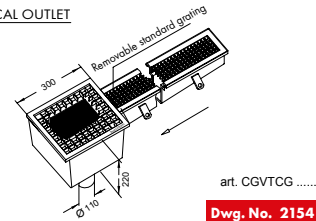

#### END HORIZONTAL OUTLET

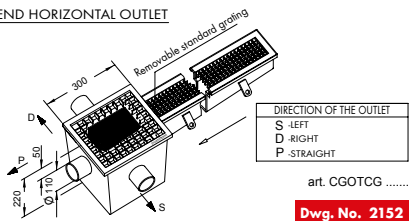

MADE TO MEASURE

www.inoxsystem.it



Inoxsystem® modular lines made to measure on request with connection flanges, reinforced edges, etc.

**Line 0810**

- Channel with grating
- Version without odor trap
- Direct outlet  $\varnothing$  63, h 100 mm
- See page 16 for more details

CHANNEL CROSS SECTION  
Art. Inoxsystem® -CGS...

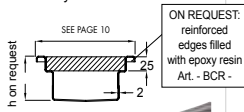

ON REQUEST:  
reinforced edges filled with epoxy resin  
Art. - BCR -



WITH HEELSAFE GRATING IDEAL FOR SWIMMING POOLS, SHOWERS AND TERRACES

CENTRAL VERTICAL OUTLET

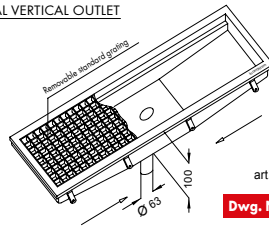

art. CGDV .....  
Dwg. No. 0812

CENTRAL HORIZONTAL OUTLET

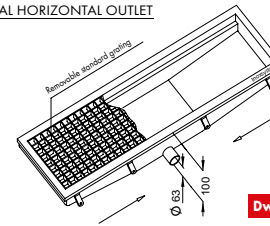

art. CGDO .....  
Dwg. No. 0814

END VERTICAL OUTLET

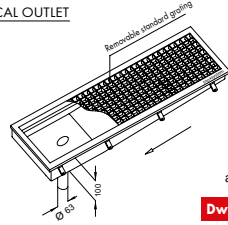

art. CGDVT .....  
Dwg. No. 0813

END HORIZONTAL OUTLET

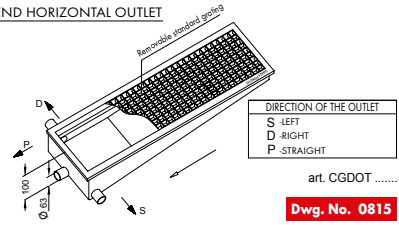

art. CGDOT .....  
Dwg. No. 0815

**Line 0460**

- "Hidden" slot channel to be installed under the floor
- Version with straight horizontal edges
- With direct outlet or odor trap,  $\varnothing$  63 mm, with inspection unit

INSTALLATION EXAMPLE

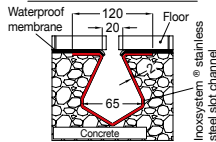

DEVELOPED FOR WATERPROOF MEMBRANE APPLICATION

CENTRAL VERTICAL OUTLET

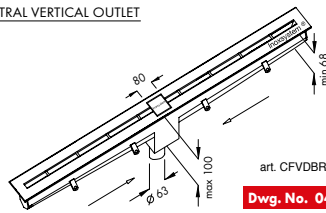

art. CFVDBRI .....  
Dwg. No. 0463

CENTRAL HORIZONTAL OUTLET

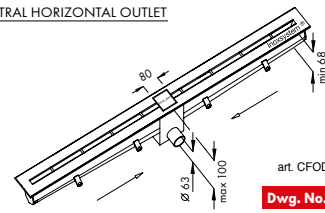

art. CFODBRI .....  
Dwg. No. 0461

END VERTICAL OUTLET

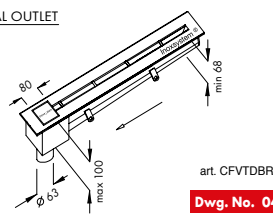

art. CFVTDBRI .....  
Dwg. No. 0464

END HORIZONTAL OUTLET

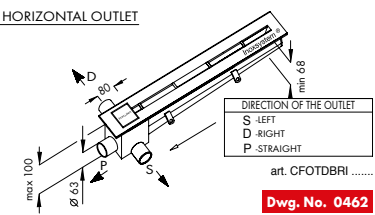

art. CFOTDBRI .....  
Dwg. No. 0462

**Line 0450**

- "Hidden" slot channel to be installed under the floor
- Version with straight horizontal edges
- Direct outlet  $\varnothing$  63 mm without inspection unit

INSTALLATION EXAMPLE

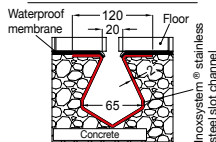

DEVELOPED FOR WATERPROOF MEMBRANE APPLICATION

CENTRAL VERTICAL OUTLET

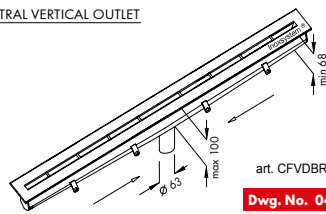

art. CFVDBR .....  
Dwg. No. 0453

CENTRAL HORIZONTAL OUTLET

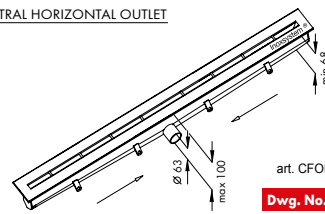

art. CFODBR .....  
Dwg. No. 0451

END VERTICAL OUTLET

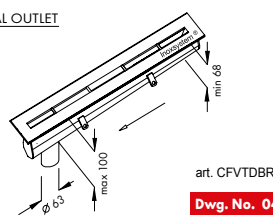

art. CFVTDBR .....  
Dwg. No. 0454

END HORIZONTAL OUTLET

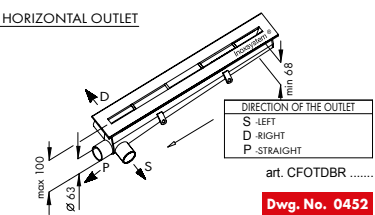

art. CFOTDBR .....  
Dwg. No. 0452

SINGLE-SLOT GRATING FOR CONCRETE TRENCH DRAINS

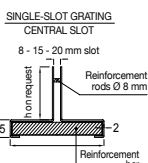

Article 4001 Dwg. No. 4001

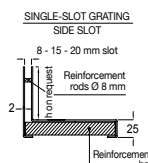

Article 4002 Dwg. No. 4002

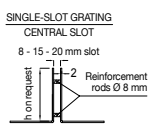

Article 4003 Dwg. No. 4003

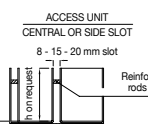

Article 4004 Dwg. No. 4004

STAINLESS STEEL GRATING FOR INSPECTION WITH FRAME



Article 0863 Dwg. No. 0863



Article 0861 Dwg. No. 0861



Article 0864 Dwg. No. 0864



Article 0865 Dwg. No. 0865

STAINLESS STEEL GRATING FOR INSPECTION WITH FRAME

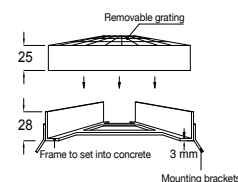

INSTALLATION EXAMPLE

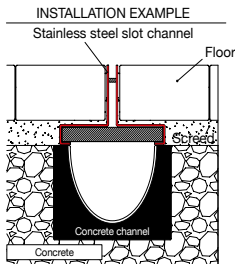
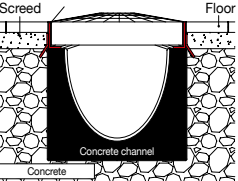

MADE TO MEASURE

www.inoxsystem.it

Inoxsystem® modular lines made to measure on request with connection flanges, reinforced edges, etc.

**Line 1450**

- 8 - 15 - 20 mm central slot
- Version with vertical edges - central slot tapered to prevent blockage
- Floor drain with 150x150 mm top cover outlet  $\varnothing$  63 mm, h 140 mm
- With odor trap and filter basket
- See page 13 for more details

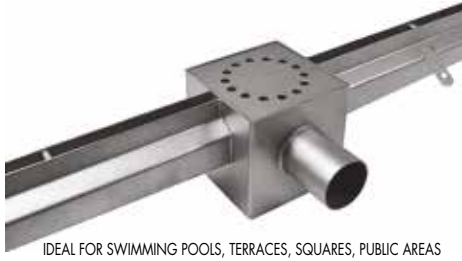
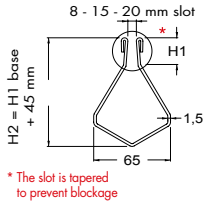

CENTRAL VERTICAL OUTLET

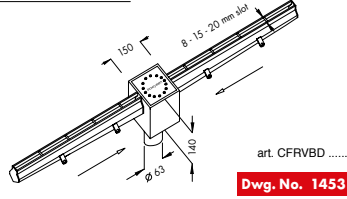

CENTRAL HORIZONTAL OUTLET

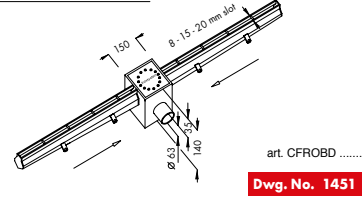

END VERTICAL OUTLET

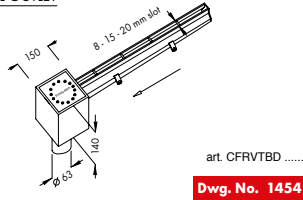

END HORIZONTAL OUTLET

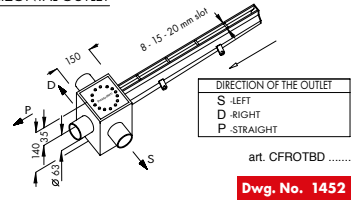

**Line 1460**

- 8 - 15 - 20 mm central slot
- Version with vertical edges - central slot tapered to prevent blockage
- Floor drain with 150x150 mm tileable top cover outlet  $\varnothing$  63 mm, h 140 mm
- With odor trap and filter basket
- See page 13 for more details

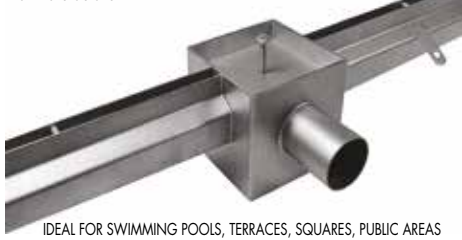
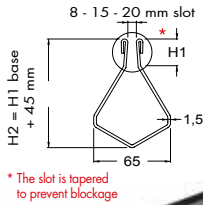

CENTRAL VERTICAL OUTLET

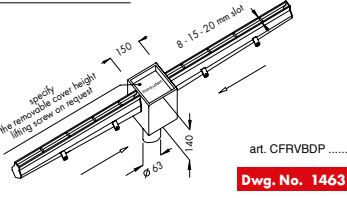

CENTRAL HORIZONTAL OUTLET

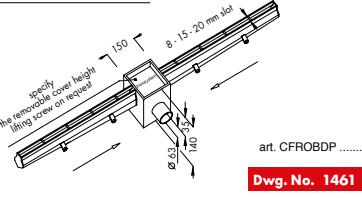

END VERTICAL OUTLET

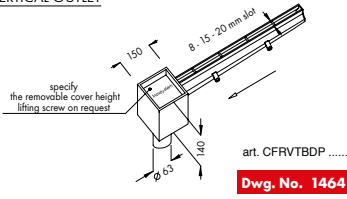

END HORIZONTAL OUTLET

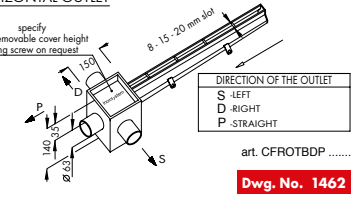

**Line 1470**

- 8 - 15 - 20 mm central slot
- Version with vertical edges - central slot tapered to prevent blockage
- 80x80 mm inspection unit with outlet  $\varnothing$  63 mm, h 100 mm
- Direct outlet without odor trap
- Tileable cover on request

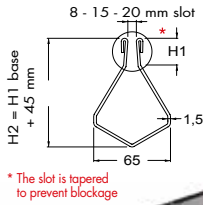

CENTRAL VERTICAL OUTLET

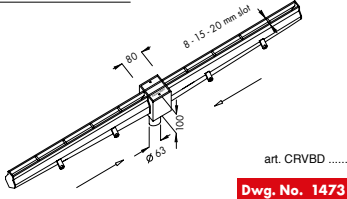

CENTRAL HORIZONTAL OUTLET

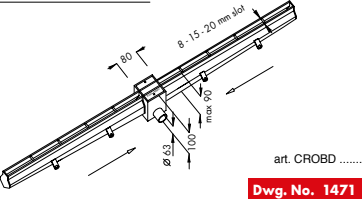

END VERTICAL OUTLET

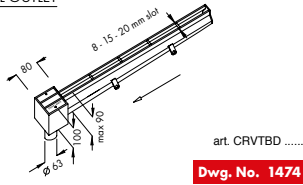

END HORIZONTAL OUTLET

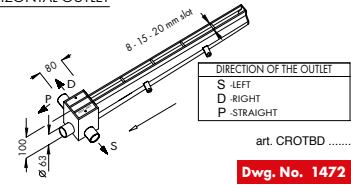

**Line 1490**

- 8 - 15 - 20 mm central slot
- Version with vertical edges - central slot tapered to prevent blockage
- Direct outlet without odor trap  $\varnothing$  63 mm
- Without inspection unit

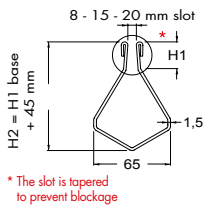

CENTRAL VERTICAL OUTLET

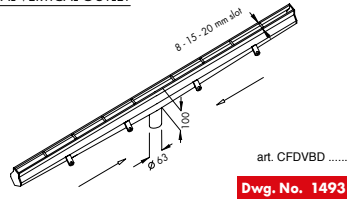

CENTRAL HORIZONTAL OUTLET

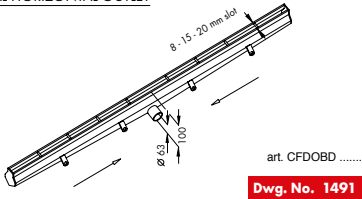

END VERTICAL OUTLET

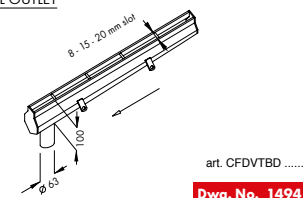

END HORIZONTAL OUTLET

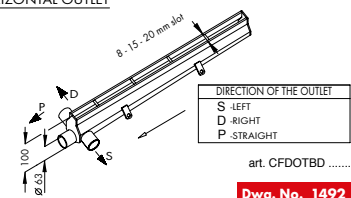

NEW LINES

www.inoxsystem.it



Stainless Steel - Think about your future

made of grade 304 stainless steel - grade 316 on request

Inoxsystem® modular lines made to measure on request with connection flanges, reinforced edges, etc.

### Line 1650

- 8 - 15 - 20 mm lateral slot
- Version with vertical edges - lateral slot tapered to prevent blockage
- Floor drain with 150x150 mm top cover outlet  $\varnothing$  63 mm, h 140 mm
- With odor trap and filter basket
- See page 13 for more details

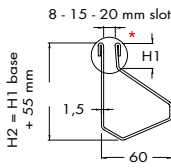

\* The slot is tapered to prevent blockage



IDEAL FOR SWIMMING POOLS, TERRACES, SQUARES, PUBLIC AREAS

#### CENTRAL VERTICAL OUTLET

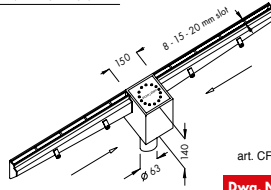

art. CFRVBDL .....  
Dwg. No. 1653

#### CENTRAL HORIZONTAL OUTLET

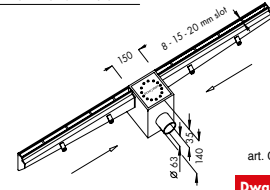

art. CFROBDL .....  
Dwg. No. 1651

#### END VERTICAL OUTLET

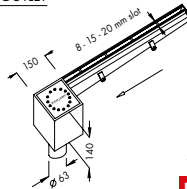

art. CFRVTBDL .....  
Dwg. No. 1654

#### END HORIZONTAL OUTLET

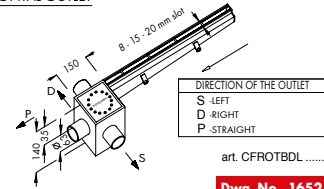

art. CFROTBDL .....  
Dwg. No. 1652

### Line 1660

- 8 - 15 - 20 mm lateral slot
- Version with vertical edges - lateral slot tapered to prevent blockage
- Floor drain with 150x150 mm tileable top cover outlet  $\varnothing$  63 mm, h 140 mm
- With odor trap and filter basket
- See page 13 for more details

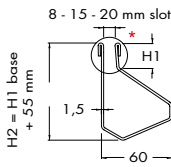

\* The slot is tapered to prevent blockage



IDEAL FOR SWIMMING POOLS, TERRACES, SQUARES, PUBLIC AREAS

#### CENTRAL VERTICAL OUTLET

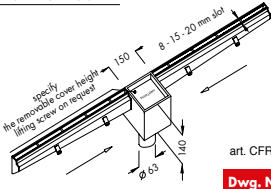

art. CFRVBDDL .....  
Dwg. No. 1663

#### CENTRAL HORIZONTAL OUTLET

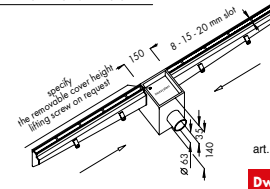

art. CFROBDLP .....  
Dwg. No. 1661

#### END VERTICAL OUTLET

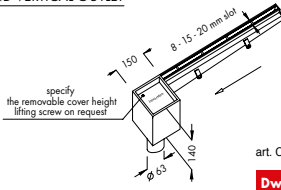

art. CFRVTBDLP .....  
Dwg. No. 1664

#### END HORIZONTAL OUTLET

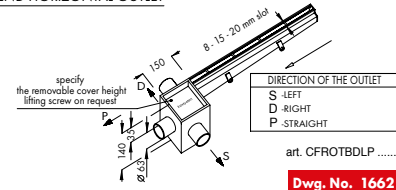

art. CFROTBDLP .....  
Dwg. No. 1662

### Line 1670

- 8 - 15 - 20 mm lateral slot
- Version with vertical edges - lateral slot tapered to prevent blockage
- 80x80 mm inspection unit with outlet  $\varnothing$  63 mm, h 100 mm
- Direct outlet without odor trap
- Tileable cover on request

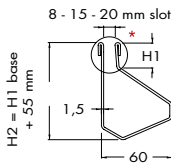

\* The slot is tapered to prevent blockage



IDEAL FOR SWIMMING POOLS, TERRACES, SQUARES, PUBLIC AREAS

#### CENTRAL VERTICAL OUTLET

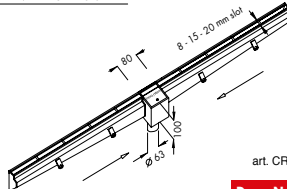

art. CRVBDL .....  
Dwg. No. 1673

#### CENTRAL HORIZONTAL OUTLET

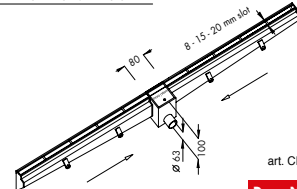

art. CROBDL .....  
Dwg. No. 1671

#### END VERTICAL OUTLET

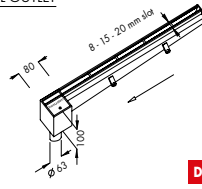

art. CROBDL .....  
Dwg. No. 1674

#### END HORIZONTAL OUTLET

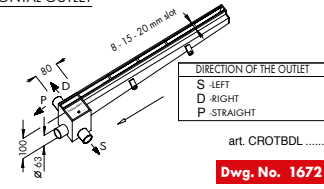

art. CROTBDL .....  
Dwg. No. 1672

### Line 1690

- 8 - 15 - 20 mm lateral slot
- Version with vertical edges - lateral slot tapered to prevent blockage
- Direct outlet without odor trap  $\varnothing$  63 mm
- Without inspection unit

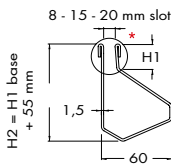

\* The slot is tapered to prevent blockage



IDEAL FOR SWIMMING POOLS, TERRACES, SQUARES, PUBLIC AREAS

#### CENTRAL VERTICAL OUTLET

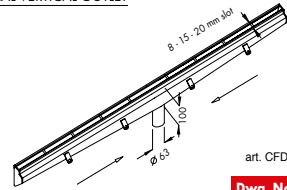

art. CFDVBDL .....  
Dwg. No. 1693

#### CENTRAL HORIZONTAL OUTLET

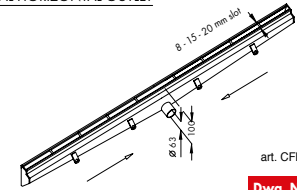

art. CFDOBDL .....  
Dwg. No. 1691

#### END VERTICAL OUTLET

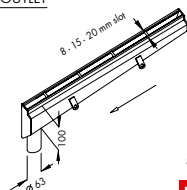

art. CFDVTBDL .....  
Dwg. No. 1694

#### END HORIZONTAL OUTLET

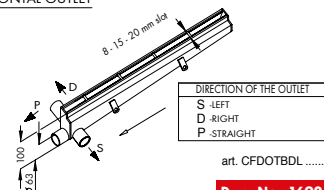

art. CFDOTBDL .....  
Dwg. No. 1692

Inoxsystem® modular lines made to measure on request with connection flanges, reinforced edges, etc.

### Line 3050

- Linear shower drain Italia IDrain
- Satin finish edge
- Satin finish closed grate
- Round shaped gully
- Removable odor trap and filter basket
- Provided with lifting hook

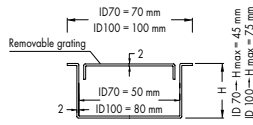

IDEAL FOR SHOWERS, CHANGING ROOMS, BATHROOMS, SWIMMING POOLS, etc.

#### CENTRAL VERTICAL OUTLET

Ø	FLOW RATE l/min	Outlet	ID 70	ID 100
50	12	12		
75	18	28		

\*Other diameter sizes on request

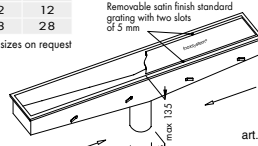

art. CISV .....

Dwg. No. 3053

#### CENTRAL HORIZONTAL OUTLET

Ø	FLOW RATE l/min	Outlet	ID 70	ID 100
40	18	28		
50	18	28		

\*Other diameter sizes on request

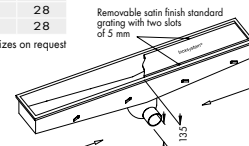

art. CISO .....

Dwg. No. 3051

#### END VERTICAL OUTLET

Ø	FLOW RATE l/min	Outlet	ID 70	ID 100
50	12	12		
75	18	28		

\*Other diameter sizes on request

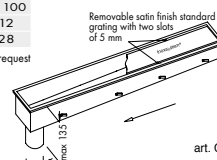

art. CISVT .....

Dwg. No. 3054

#### END HORIZONTAL OUTLET

Ø	FLOW RATE l/min	Outlet	ID 70	ID 100
40	18	28		
50	18	28		

\*Other diameter sizes on request

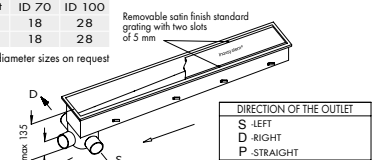

art. CISOT .....

Dwg. No. 3052

### Line 3020

- Linear shower drain Italia IDrain
- With no visible edge
- Tileable cover
- Round shaped gully
- Removable odor trap and filter basket
- Provided with lifting hook

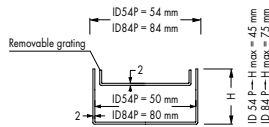

IDEAL FOR SHOWERS, CHANGING ROOMS, BATHROOMS, SWIMMING POOLS, etc.

#### CENTRAL VERTICAL OUTLET

Ø	FLOW RATE l/min	Outlet	ID 54 P	ID 84 P
50	12	12		
75	18	28		

\*Other diameter sizes on request

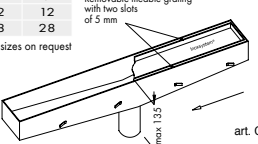

art. CISVP .....

Dwg. No. 3023

#### CENTRAL HORIZONTAL OUTLET

Ø	FLOW RATE l/min	Outlet	ID 54 P	ID 84 P
40	18	28		
50	18	28		

\*Other diameter sizes on request

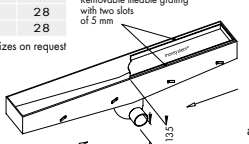

art. CISOP .....

Dwg. No. 3021

#### END VERTICAL OUTLET

Ø	FLOW RATE l/min	Outlet	ID 54 P	ID 84 P
50	12	12		
75	18	28		

\*Other diameter sizes on request

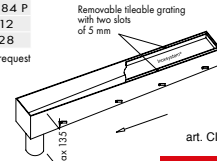

art. CISVTP .....

Dwg. No. 3024

#### END HORIZONTAL OUTLET

Ø	FLOW RATE l/min	Outlet	ID 54 P	ID 84 P
40	18	28		
50	18	28		

\*Other diameter sizes on request

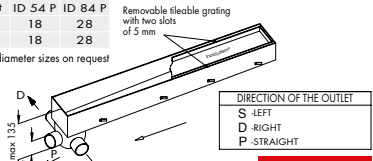

art. CISOTP .....

Dwg. No. 3022

### Line 3030

- Linear shower drain Italia IDrain
- Folded edge
- Satin finish closed grate
- Round shaped gully
- Removable odor trap and filter basket
- Flange for waterproof membrane application
- /L-profile to edge a floor
- Provided with lifting hook

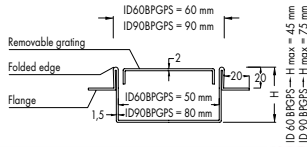

IDEAL FOR SHOWERS, CHANGING ROOMS, BATHROOMS, SWIMMING POOLS, etc.

#### CENTRAL VERTICAL OUTLET

Ø	FLOW RATE l/min	Outlet	ID 60 BPGS	ID 90 BPGS
50	12	12		
75	18	28		

\*Other diameter sizes on request

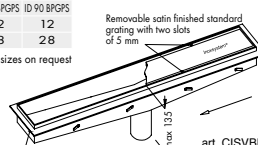

art. CISVBPGS .....

Dwg. No. 3033

#### CENTRAL HORIZONTAL OUTLET

Ø	FLOW RATE l/min	Outlet	ID 60 BPGS	ID 90 BPGS
40	18	28		
50	18	28		

\*Other diameter sizes on request

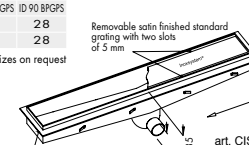

art. CISOBPGS .....

Dwg. No. 3031

#### END VERTICAL OUTLET

Ø	FLOW RATE l/min	Outlet	ID 60 BPGS	ID 90 BPGS
50	12	12		
75	18	28		

\*Other diameter sizes on request

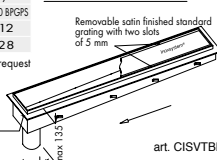

art. CISVTBPGS .....

Dwg. No. 3034

#### END HORIZONTAL OUTLET

Ø	FLOW RATE l/min	Outlet	ID 60 BPGS	ID 90 BPGS
40	18	28		
50	18	28		

\*Other diameter sizes on request

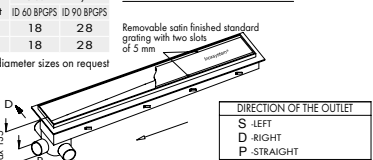

art. CISOTBPGS .....

Dwg. No. 3032

### Line 3040

- Linear shower drain Italia IDrain
- Satin finish edge
- Satin finish closed grate
- Round shaped gully
- Removable odor trap and filter basket
- Flange for waterproof membrane application
- /L-profile to edge a floor
- Provided with lifting hook

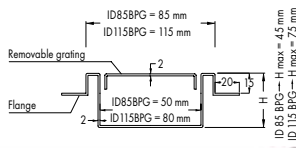

IDEAL FOR SHOWERS, CHANGING ROOMS, BATHROOMS, SWIMMING POOLS, etc.

#### CENTRAL VERTICAL OUTLET

Ø	FLOW RATE l/min	Outlet	ID 85 BPG	ID 115 BPG
50	12	12		
75	18	28		

\*Other diameter sizes on request

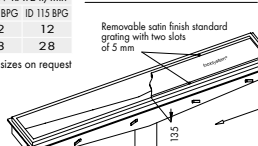

art. CISVBPG .....

Dwg. No. 3043

#### CENTRAL HORIZONTAL OUTLET

Ø	FLOW RATE l/min	Outlet	ID 85 BPG	ID 115 BPG
40	18	28		
50	18	28		

\*Other diameter sizes on request

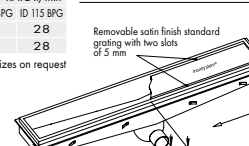

art. CISOBPG .....

Dwg. No. 3041

#### END VERTICAL OUTLET

Ø	FLOW RATE l/min	Outlet	ID 85 BPG	ID 115 BPG
50	12	12		
75	18	28		

\*Other diameter sizes on request

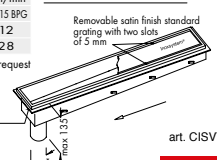

art. CISVTBPG .....

Dwg. No. 3044

#### END HORIZONTAL OUTLET

Ø	FLOW RATE l/min	Outlet	ID 85 BPG	ID 115 BPG
40	18	28		
50	18	28		

\*Other diameter sizes on request

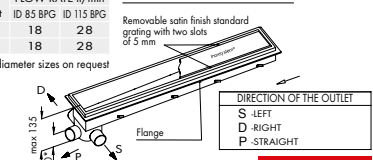

art. CISOTBPG .....

Dwg. No. 3042



made of grade 304 stainless steel - grade 316 on request  
Inoxsystem® modular lines made to measure on request with connection flanges, reinforced edges, etc.

NEW LINES

**Line 3150**

- Linear shower drain Italia IDrain
- Satin finish edge
- Satin finish closed grate
- Direct outlet with removable filter basket
- Without odor trap
- Provided with lifting hook

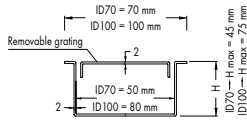

IDEAL FOR SHOWERS, CHANGING ROOMS, BATHROOMS, SWIMMING POOLS, etc.

**CENTRAL VERTICAL OUTLET**

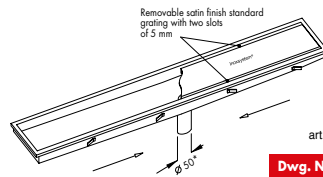

**CENTRAL HORIZONTAL OUTLET**

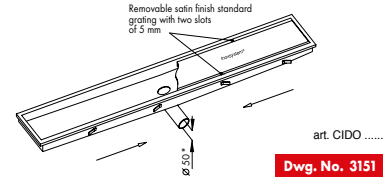

**END VERTICAL OUTLET**

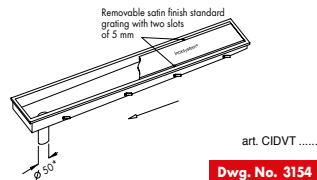

**END HORIZONTAL OUTLET**

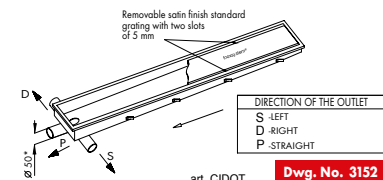

**Line 3120**

- Linear shower drain Italia IDrain
- With no visible edge
- Tileable cover
- Direct outlet with removable filter basket
- Without odor trap
- Provided with lifting hook

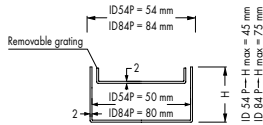

IDEAL FOR SHOWERS, CHANGING ROOMS, BATHROOMS, SWIMMING POOLS, etc.

**CENTRAL VERTICAL OUTLET**

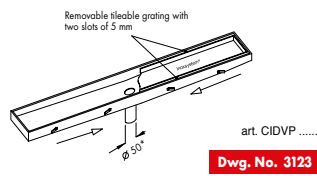

**CENTRAL HORIZONTAL OUTLET**

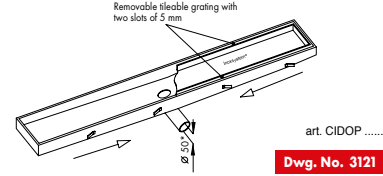

**END VERTICAL OUTLET**

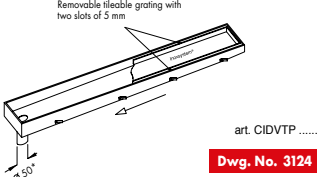

**END HORIZONTAL OUTLET**

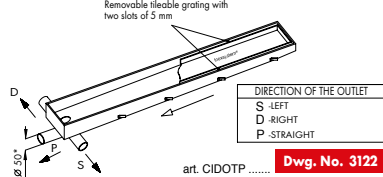

**Line 3130**

- Linear shower drain Italia IDrain
- Folded edge
- Satin finish closed grate
- Direct outlet with removable filter basket
- Without odor trap
- Flange for waterproof membrane connection
- /L-profile to edge a floor
- Provided with lifting hook

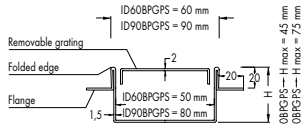

IDEAL FOR SHOWERS, CHANGING ROOMS, BATHROOMS, SWIMMING POOLS, etc.

**CENTRAL VERTICAL OUTLET**

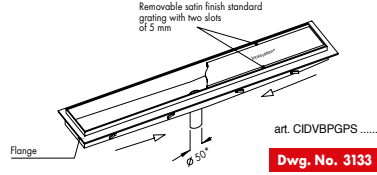

**CENTRAL HORIZONTAL OUTLET**

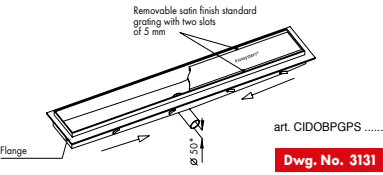

**END VERTICAL OUTLET**

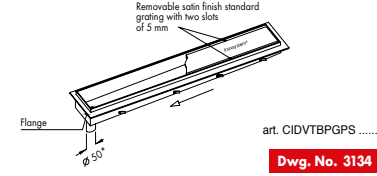

**END HORIZONTAL OUTLET**

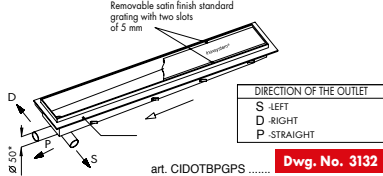

**Line 3140**

- Linear shower drain Italia IDrain
- Satin finish edge
- Satin finish closed grate
- Direct outlet with removable filter basket
- Without odor trap
- Flange for waterproof membrane connection
- /L-profile to edge a floor
- Provided with lifting hook

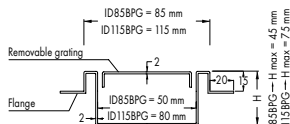

IDEAL FOR SHOWERS, CHANGING ROOMS, BATHROOMS, SWIMMING POOLS, etc.

**CENTRAL VERTICAL OUTLET**

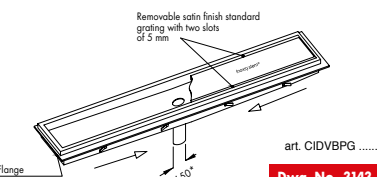

**CENTRAL HORIZONTAL OUTLET**

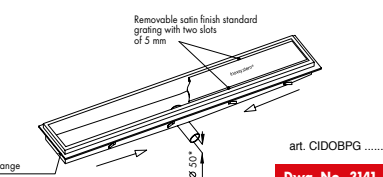

**END VERTICAL OUTLET**

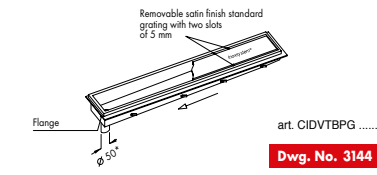

**END HORIZONTAL OUTLET**

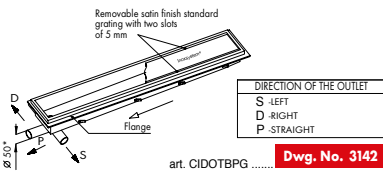

www.inoxsystem.it



### WE ARE ISO 9001 CERTIFIED



The quality management system of **INOXSYSTEM®** is in compliance with the standard **ISO 9001** for the following fields of activities

- DESIGN AND MANUFACTURE OF STAINLESS STEEL DRAINAGE SYSTEMS AND MANHOLE COVERS INSTALLED WITHIN CIVIL OR INDUSTRIAL AREAS SUBJECTED TO PEDESTRIANS AND/OR VEHICULAR TRAFFIC.**
- DESIGN AND MANUFACTURE OF STAINLESS STEEL FINISHING AND DECORATIVE ACCESSORIES FOR BUILDING WORKS IN CIVIL AND INDUSTRIAL AREAS.**

#### ISO 9001

is defined as the international standard that specifies requirements for a quality management system (QMS). Organizations use the standard to demonstrate the ability to consistently provide products and services that meet customer and regulatory requirements.

### STAINLESS STEEL GRADE 304 AND 316

All stainless steels have two characteristics in common - they contain chromium and possess resistance to corrosion. This remarkable immunity to attack is conferred by the naturally occurring chromium-rich oxide film which is always present on the surface of the stainless steel.

If the oxide film is removed or damaged by abrasion, or if the raw metal surface is exposed by cutting the steel, a new film is immediately formed by reaction between the steel and the atmosphere or other sources of oxygen.

Protection is instantaneously re-established, and it is therefore possible to choose a steel which is quite unaffected even by aggressive marine atmospheres, many acids, alkalis and other chemicals.

#### History - Development of stainless steel in the First World War



The discovery of stainless steel is due to the British *Woods and Clark* who, in 1872, patented an iron alloy containing 35% by weight of chromium and resistant to acids. Industrialization, however, took place only years later when in 1913 *Harry Brearley* (pictured), experimenting with steels for firearms, discovered that one of his steel specimen with 13-14% of chromium and with a carbon content relatively high (0.25%) did not rust when exposed to the atmosphere.

The first mention of this technological progress dates back to 1915 and is found in an article in the New York Times about the use of this class of steel for cutlery, praising its resistance to corrosion even in contact with the organic acids contained in foods.

The subsequent progress of metallurgy between the forties and sixties of the 20th century increased stainless steels development and their applications but it was only at the beginning of 2000, initially in Europe, that their

hygienic and anti-bacterial properties were discovered and stainless steel was first used where hygienic performance is essentials, such as in floor drainage.

Stainless steel drainage systems find nowadays their application in many sectors, especially in the food industry (professional kitchens, slaughterhouses, dairies, wineries, breweries, mineral water plants, bakeries, ice cream parlors), pharmaceutical industry but also for civil use, thanks the resistance, durability and aesthetic finish of this material.

Steel drainage systems respond efficiently and effectively to current international health and safety regulations.

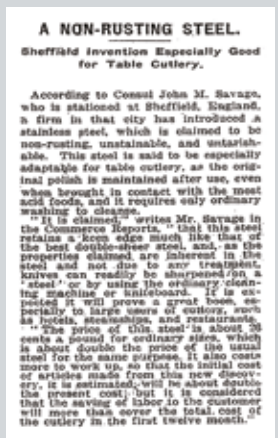

First public mention of stainless steels  
NYT 1-31-1915